



Overview of Secondary Surveillance Radar (SSR) and Identification Friend/Foe (IFF) Systems

*Presented by Telephonics Chief Engineer
Frank Dominick Messina*

- Introduction to SSR/IFF
 - Basic Terms and Definitions
 - Overview
- History of SSR and IFF
- Governing Documents
- IFF System Architecture
 - SSR/IFF System Block Diagram
 - Scanning the Airspace
 - Sidelobe Suppression
 - Antenna Dwell Time
 - 2-Channel vs 3-Channel Antenna Systems
 - Azimuth Determination
 - RF Link Budgets

- Description of SSR/IFF Modes
 - Overview of Modes
 - SIF/ATCRBS Modes
 - Mode S
 - Mode 5
- SSR/IFF Processing Challenges
 - False Replies Unsynchronized in Time (FRUIT)
 - Garble
 - Gain Time Control (GTC)
 - Multi-Path
 - Antenna Pattern Distortion
- New Initiatives in SSR and IFF



Part I



Introduction to SSR/IFF

Acronyms

SSR: Secondary Surveillance Radar

IFF: Identification Friend or Foe

ATC: Air Traffic Control

ATCRBS: Air Traffic Control Radar Beacon System

SIF: Selective Identification Feature

Mode S: Mode Select Beacon

Mark XA or Mk XA: System with IFF/SSR Modes 1, 2 and 3/A

Mark XII or Mk XII: Mark XA with the addition of Secure Mode 4

Mark XIIA: Mark XII with the addition of Secure Mode 5

AIMS: ATCRBS IFF Mark XII Systems

STANAG: NATO Standardization Agreement

ICAO: International Civil Aviation Organization

RTCA: Radio Technical Commission for Aeronautics

ADS-B: Automatic Dependent Surveillance Broadcast

Identification, Friend or Foe (IFF)

- A system using electromagnetic transmissions to which equipment carried by friendly forces automatically responds, for example, by emitting pulses, thereby distinguishing themselves from enemy forces
- The Secondary Surveillance Radar (SSR) system used in modern Air Traffic Control (ATC) is an outgrowth of the military IFF system used during World War II
- The IFF equipment carried by modern military aircraft is compatible with the transponder system used for civilian ATC

IFF/SSR System

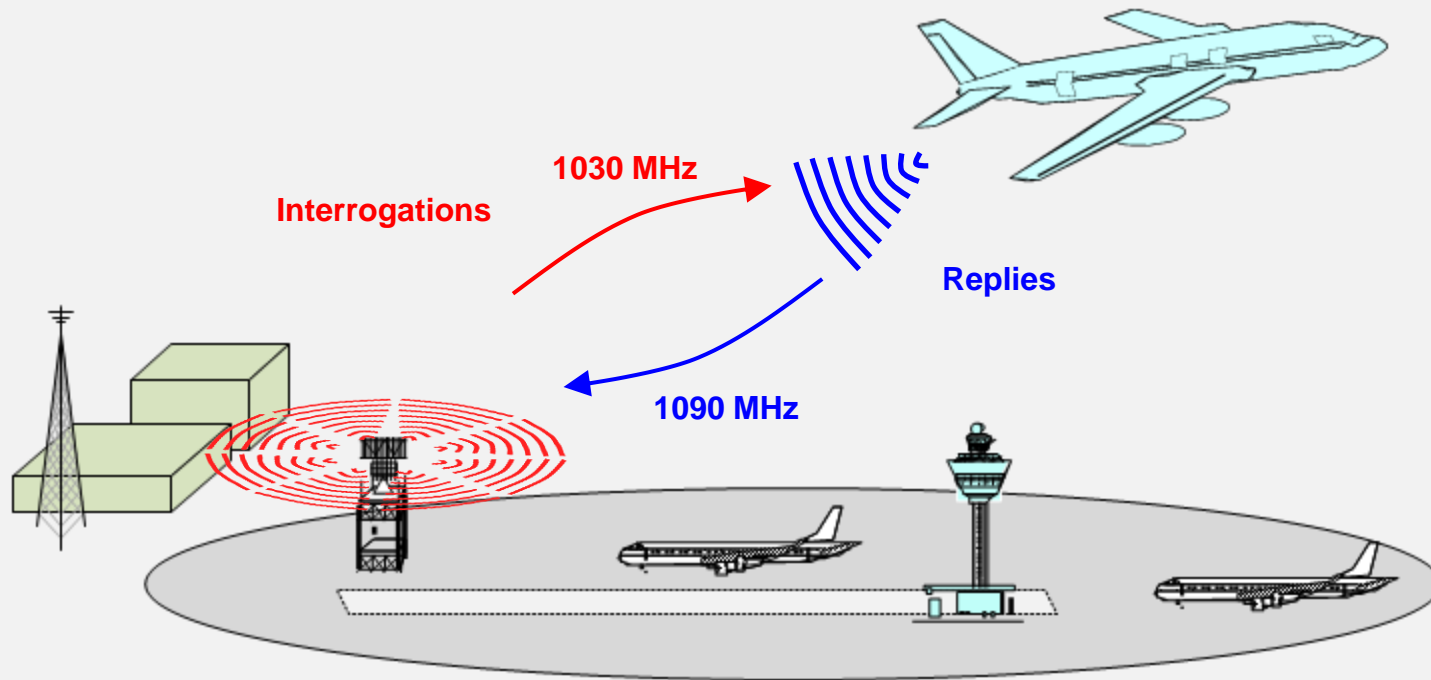

IFF/SSR System (continued)

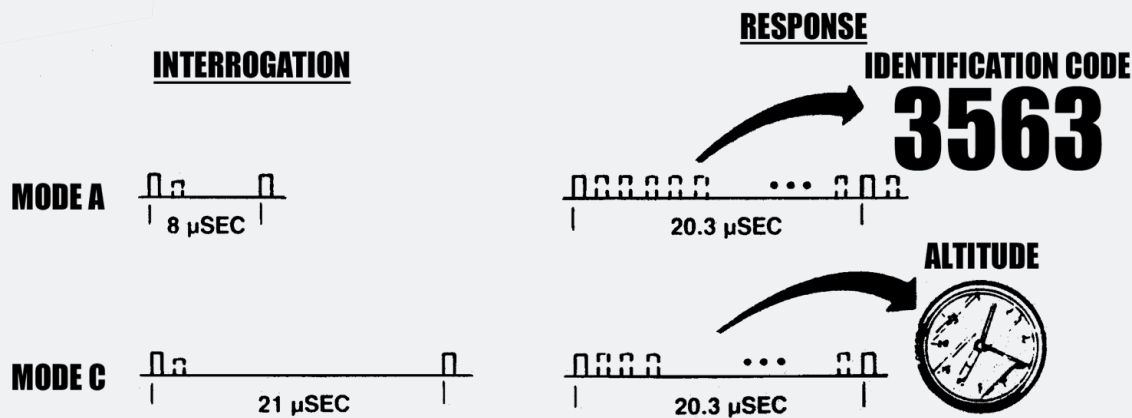
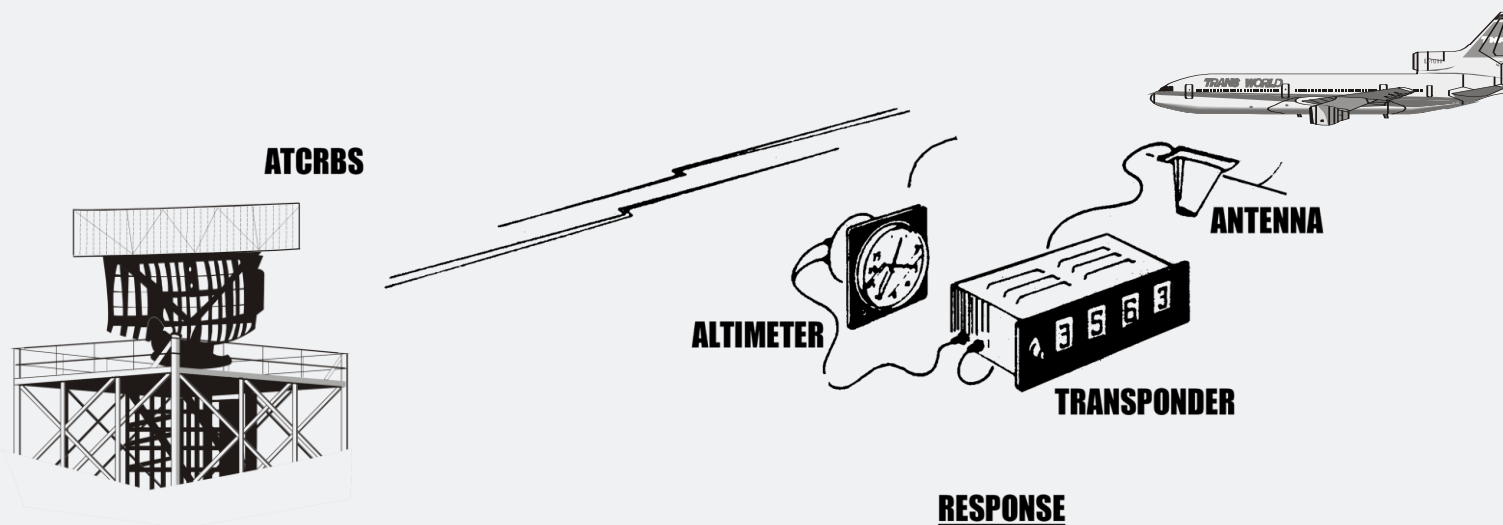

Purpose

- Goal of the System – Locate, Separate and Identify Aircraft
- Radar-Like Techniques To Locate Aircraft
 - Directional Antenna Used to Broadcast Interrogations and Receive Replies
 - Time of Transmission-Return Used to Measure Aircraft Range
 - Direction of Antenna Used to Measure Aircraft Azimuth
- Communications-Like Techniques to Identify and Separate Aircraft
 - Aircraft Responses Include Identifying Data, Including Aircraft Altitude
 - Cryptography used to identify military friends
- Cooperative System Requiring a Transponder on All Aircraft
 - Communications Protocol Must Be Strictly Defined and Adhered to for Meeting Interoperability

Purpose (in other words)

To aid the Air Traffic Controller and IFF Operator do their job to Identify, Locate and Separate Aircraft

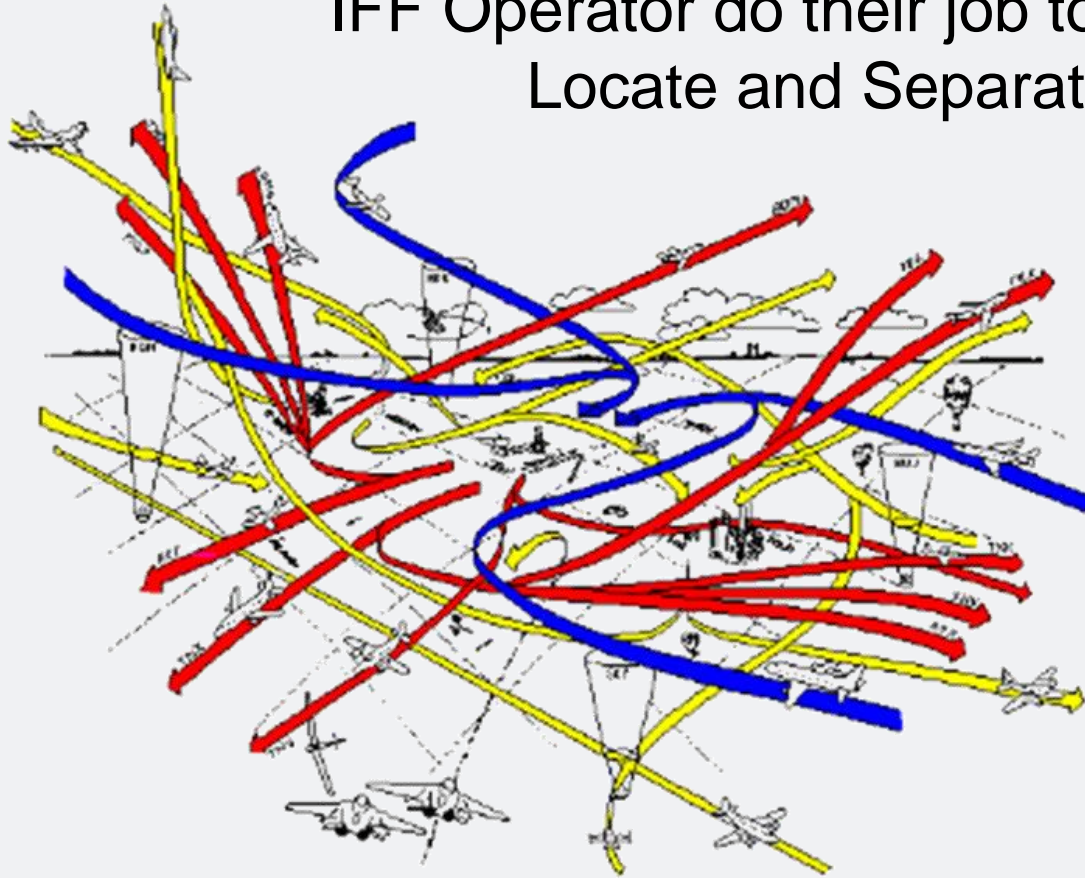

Equipment – ATC and IFF Examples

Secondary Surveillance Radar:

A radio direction system based on the comparison of reference signals with radio signals retransmitted from the position to be determined. An example of Secondary Surveillance Radar is the transponder-based surveillance of aircraft.



Telephonics
SkySearch
3000
System



ATC
Facility

Transponder

The IFF/SSR beacon transmitter-receiver receives signals from an interrogator and selectively replies with a specific pulse group (code) only to those interrogations being received on the mode to which it is set.



Civil Aircraft
Transponder

Military Aircraft Transponder &
Crypto Computer



Equipment – ATC and IFF Examples Cont:



Telephonics SFF-44
Small Form Factor
Interrogator
for mobile applications



Telephonics AN/UPX-44
Long Range Interrogator
for Ground Applications



KIV-78
IFF
Cryptographic
Computer



KIV-77
IFF
Cryptographic
Computer

1. The Interrogator is the device that generates a transmission of a signal or combination of signals intended to trigger a response from a Transponder.
2. A station or device that requests another station or device to identify itself or to give its status.

Multi-Band, Multi-Sector Passive IFF/SSR Detection and Reporting System (PDRS)



USAF RC 135 Rivet Joint Aircraft



**Telephonics
AN/UPR-4(V) PDRS
Passive SSR/IFF**



**Telephonics M5OAS Active/Passive
SSR/IFF (Transportable System
supports all SSR/IFF modes)**

1. A device that passively receives Civil and/or Military transponder squitter transmissions and provides reports aircraft 3D GPS position and other aircraft information.
2. ATC/IFF Modes Supported by PDRS: Mode S Automatic Dependent Surveillance Broadcast (ADS-B), Universal Access Transceiver (UAT), Military Mode 5 Level 2/Level 2B
3. For ground systems, the PDRS provides multi-beam (six), multi-band (2) antenna elements within the Radom, which are spaced 60 degrees apart in Azimuth. This multi-beam configuration provides superior detection performance, greater surveillance range and anti-jam protection. In addition minimizes the interference issues associated with Omni-directional antennas

Air Traffic Control (ATC) and IFF Displays



The display that Air Traffic Controllers or military IFF operators use to show aircraft information, identify aircraft and to control the movement of aircraft.



IFF/SSR Display

- The display that air traffic controllers or military IFF operators use to show target information, identify targets, and to control the movement of aircraft

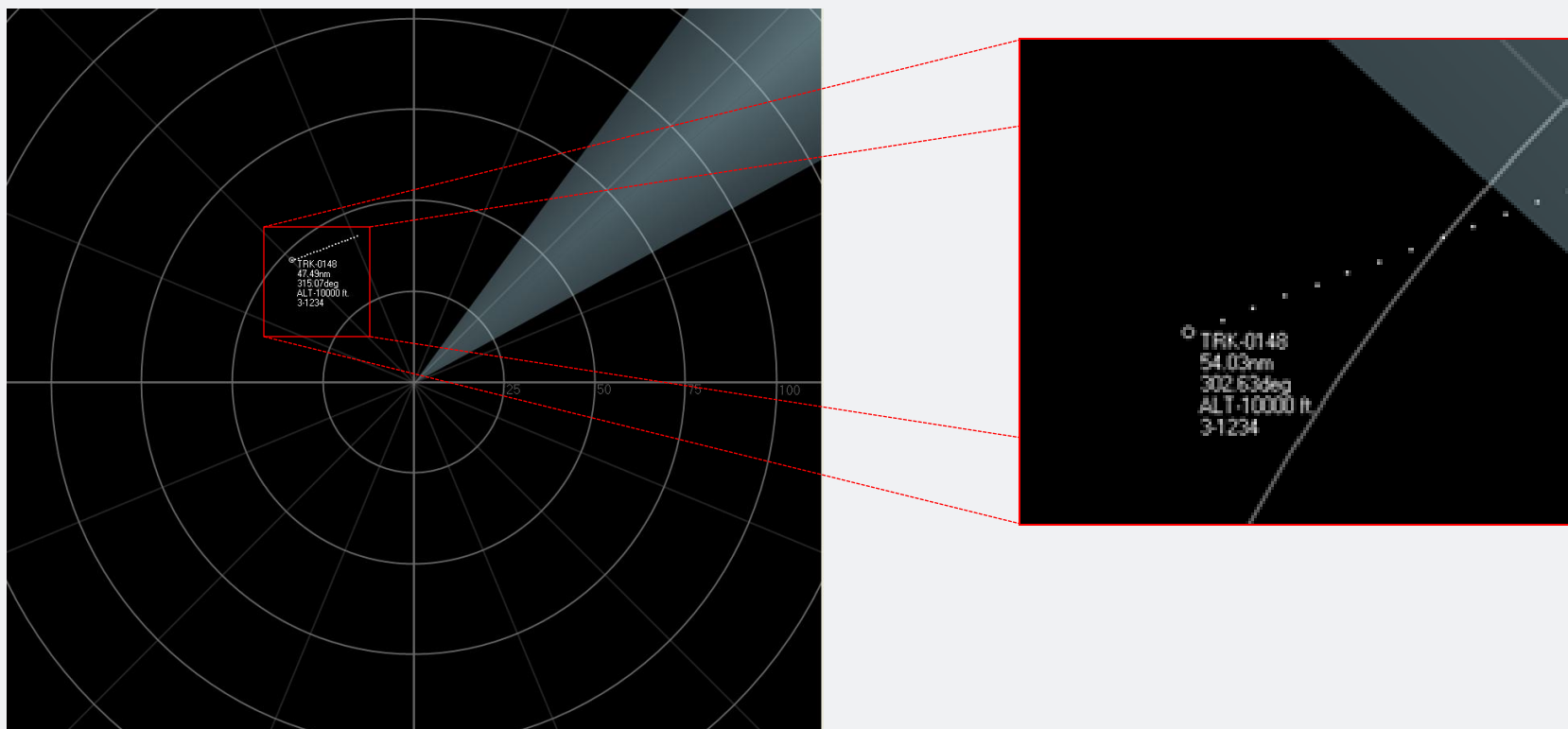



History of SSR and IFF

The Early Years

- Throughout time, it has always been important to know who one's friends are.
- Nowhere has this been more obvious than in military conflicts, where for centuries, flags, banners, insignia and uniforms have allowed adversaries to distinguish their allies from others who might have less friendly intentions.
- Visual identification was the IFF of the day for years as long as conflicts were more or less face to face and visual identification was possible.
- Just as World War II began, the widespread use of aircraft caused a dramatic change.
- The threats were fast moving, so by the time the visual identification was possible, it was often too late to prevent destruction.

The Early Years (continued)

- New battle zones quickly became chaotic mixtures of friendly and hostile forces with many isolated units operating autonomously.
- Visual means were and still are an important method of discriminating between friends and enemies. Some children of the late thirties and early forties even studied aircraft identification handbooks and black silhouettes enabling them to tell the difference between aircraft.
- During the 1940's early forms of radar were emerging and, although it seemed to offer a solution to the problem, a major drawback soon became evident.
- Early radars could detect incoming aircraft at considerable distance, but it could not tell what kind of aircraft had been spotted or what force they belonged to. The tragic events at Pearl Harbor might have been changed had the radar been able to identify as well as detect the incoming Japanese aircraft.

World War II

- Early in World War II, British airmen were puzzled by the strange behavior of German fighter aircraft. Occasionally and without apparent reason, the German planes would simultaneously roll over.
- The British eventually intercepted radio signals from the ground that always preceded this maneuver. It was then realized that by rolling over at a predetermined signal the Germans were changing the polarization of the radar reflections picked up by their own ground radars. They created a distinctive response on the radars that differed from others so German radar operators could identify their friendly forces.
- As crude and simple as it was, this constituted the first attempt at an electronic IFF system. It incorporated the basic structure of all cooperative IFF systems that followed: a challenge or question (the coded radio message) and a specific response (the roll over that caused a change in the reflected radar signal).

The First Active IFF Systems

- That first German IFF maneuver was considered a passive system in that the returned signal was still just a reflection of the radar energy sent from the ground.
- Around 1940, an active system, designated the Mk I, was put into service. It used a receiver aboard each aircraft that broke into oscillation and acted as a transmitter when it received a radar signal.
- The system was developed further by the addition of a separate transmitter that was tuned through the radar bands simultaneously with the receiver and was triggered by signals from the receiver. This greatly increased the strength of the return signal and the return range.
- Known as Mk III, it also could be programmed to respond in one of six different codes thus providing some further degree of identification.

Further Refinements

- After the war, with rapid technical developments, the need for efficient and reliable IFF systems led to a long series of further refinements that eventually evolved into the modern IFF systems in use today.
- Modern IFF systems are basically Question/Answer systems.
- An interrogator system sends out a coded radio signal that asks any number of queries, including: Who are you?
- The interrogation code or challenge, is received by an electronic system known as a transponder located on the target aircraft.
- If the transponder receives the proper electronic code from an interrogator, it automatically transmits the requested identification back to the interrogating radar.
- The US Military fielded unsecure military IFF in the 1950s, which included the SIF modes 1, 2, and 3.

Introduction of SSR for Civilian ATC

- By the 1960's civilian air traffic in the United States had increased so much that air traffic controllers began to have their own identity crisis.
- The radar screens in high traffic areas became so cluttered with primary returns that it was becoming difficult to know which blip represented which plane. In addition, the primary radar was not capable of determining aircraft altitudes.
- A system similar to and compatible with, military IFF systems was authorized and introduced by the civilian air traffic control authorities.
- Since civilian air traffic control deals only (hopefully) with friendly aircraft, it is more properly called the Air Traffic Control Radar Beacon System (ATCRBS).

Introduction of Secure IFF

- The original reason for IFF systems was to identify friendly forces in a battlefield environment.
- It is essential that hostile forces not be able to use the system to identify themselves as friendly even if the physical IFF equipment should fall into their hands.
- The secure mode is used exclusively for military purposes. This mode uses special interrogation signals which contains information that tells the transponder it is about to receive a secure message.
- A very high degree of security to the identification system is ensured through the use of key codes and powerful cryptographic techniques.
- The initial cryptographically secure IFF mode used by the US military was Mode 4, which was defined and fielded in the 1960s. Mode 4 required properly keyed cryptographic computers for the interrogator and for all friendly transponders.

Improvements to Civilian SSR

- The SSR system used for Air Traffic Control (ATCRBS) has many inherent weaknesses, largely in the area of self-interference.
- In the 1970s, the International Civil Aviation Organization (ICAO) began work to define a new mode of operation for civilian SSR, called Mode S. The S stands for the primary new feature of the new mode, the ability to Selectively interrogate specific aircraft.
- While Mode S was defined in the 70s, full deployment has taken decades. Europe adopted Mode S earlier than the US, and required that all aircraft, including general aviation, be equipped with Mode S transponders by 2000.
- In the 1990s, an automatic mode was defined which used emerging GPS technology to broadcast aircraft GPS position without interrogations. This mode, ADS-B, was adopted by the US, with a mandate for all aircraft to be equipped by 2020.

Improvements to Military IFF

- In the 1990s, the US Military began work on a new secure mode of IFF, Mode 5. Based on experiences with Mode 4, NATO was brought in as a full partner in the development.
- An initial specification for the Mode 5 system was published in 1997, and an updated version addressing significant issues in the original specification was published in 2003. Manufacturers have been fielding equipment since that time frame, with the US and its Allies targeting full operating capability in 2020.
- The new Mode 5 system addresses many of the inherent problems with Mode 4, including resolution of closely spaced targets, and providing secure identification data. Additionally, a sub-mode of Mode 5, Mode 5 Level 2, provides target GPS position data, which can be retrieved via an interrogation, or automatically broadcast.
- Recently, an extension of the Mode 5 Level 2 capability has been defined, Mode 5 Level 2 Bravo, which provides cryptographically secured services similar to ADS-B. Transponders with this capability have been prototyped and flight tested.



Governing Documents

Military

- Since SSR and IFF are essentially communication systems, the electronic protocol for the waveforms and data transmitted by the system must be strictly adhered to, in order to ensure equipment interoperability. These protocols are defined in several documents:
- DoD AIMS Program Office Provides US Military IFF Specifications:
 - 65-1000 – Defined Mark XII (SIF and Mode 4)
 - 97-1000 – Initial Definition of Mark XIIA (SIF, Mode 4, and Mode 5)
 - 03-1000 – Updated Mode 5 Definition
 - 17-1000 – Removed Mode 4 From Requirements
 - Other Documents Provide Additional Requirements/Guidance
- NATO Provides STANAGs for Various Equipment Specification
 - STANAG 4193 Defines IFF Specification
 - Edition 2 Provided Initial Definition of Mark XIIA
 - Edition 3 Provided Updated Definition, and Reconciled Differences between 4193 and AIMS 03-1000.

Civil

- ICAO (International Civilian Aviation Organization) Provides Civilian SSR Specifications:
 - ICAO Annex X, Volumes 3 & 4 Define Civilian Mode 3/A, C, and S
 - Other Documents Provide Additional Definitions (9871 Defines ADS-B)
- RTCA (Radio Technical Commission for Aeronautics) Provides Additional Guidance For Transponders
 - DO-260 Defines Transponder Minimum Operational Parameters (MOPS)
 - DO-282 Defines Universal Access Transceiver (UAT) Operation
- EUROCONTROL – European Civil Aviation Organization
 - ASTERIX – Common Interface Specifications For Air Traffic Control Radars
 - Mode S Ground Station – A Complete Specification for a Mode S ATC Radar
 - Includes Mode S Clustering



IFF System Architecture

SSR/IFF System Block Diagram

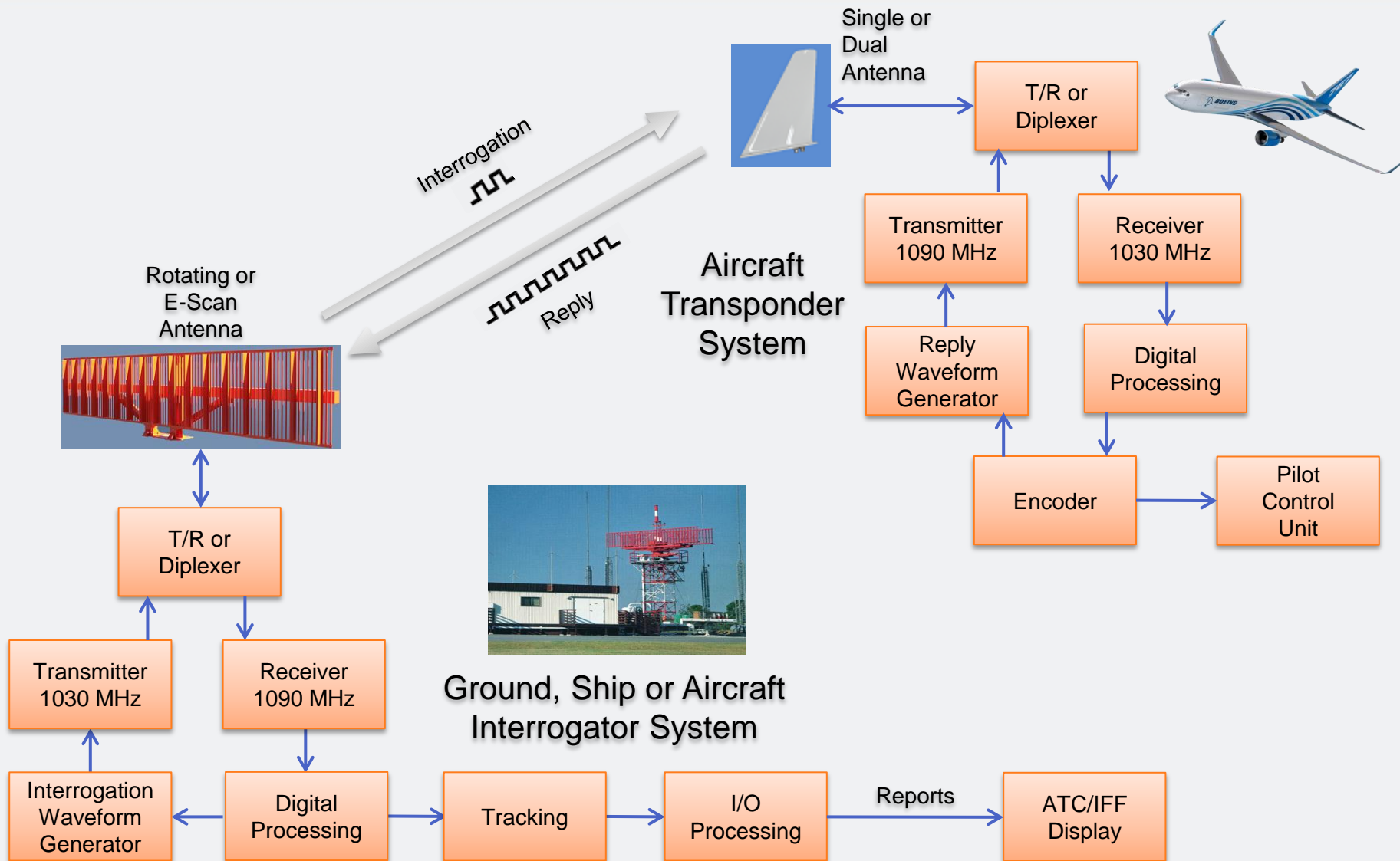

Fan-Shaped Beam

- Defined for a target with an azimuth angle, ϕ (relative to north), and a slant range, R

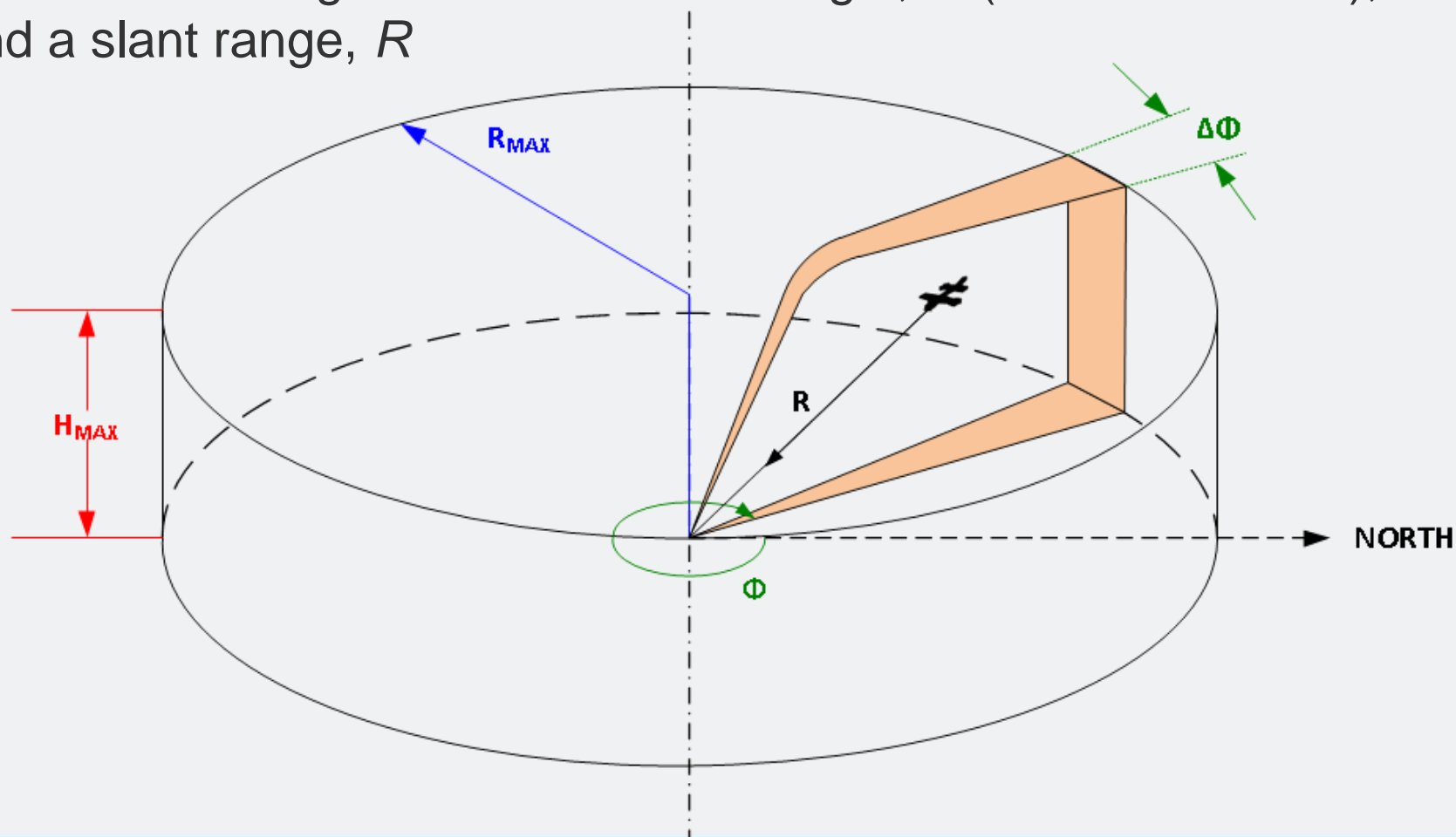

Sweep vs. Scan

- In IFF/SSR systems, a **Sweep** is defined as the interim distance from zero range to maximum range
 - **Sweep** time or Pulse Repetition Interval (PRI) is the time between successive IFF/SSR interrogations
 - Typically 2.2 to 6.6 ms, depending on the system range requirements
- In IFF/SSR systems, a **Scan** is a 360° revolution of the antenna
 - This is typically one (1) twelve to (12) seconds, depending on the system update requirements
- **Note:** For all those Primary Radar people who always get these terms “backwards” when you SWEEP a floor, you don’t do it by swinging the broom in circles, you do it by moving the broom with a straight line radial motion. When you SCAN the horizon you don’t keep your head looking out in one direction, you scan azimuthally.



SWEEP

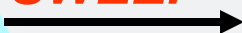

Hopefully this helps to clear up any confusion



SCAN



Range

- The range of a target is calculated by measuring the time between the interrogation reference pulse (P_3 for SIF) and time of receipt of the first framing pulse (F_1) of the reply minus the turnaround time of the transponder
 - One (1) Nautical Mile (NM) = 12.359 μsec

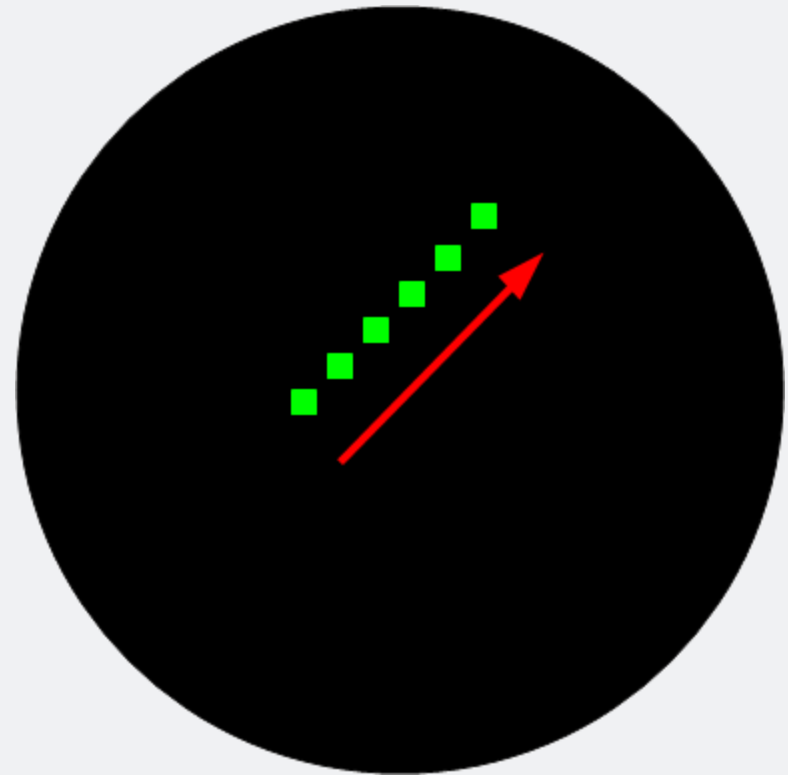

Azimuth

- The two ways of determining target azimuth are the beamsplit method and the monopulse method
 - Monopulse azimuth determination is about five (5) times more accurate
 - Both methods will be covered in detail later in the presentation
 - Discussed in greater detail later

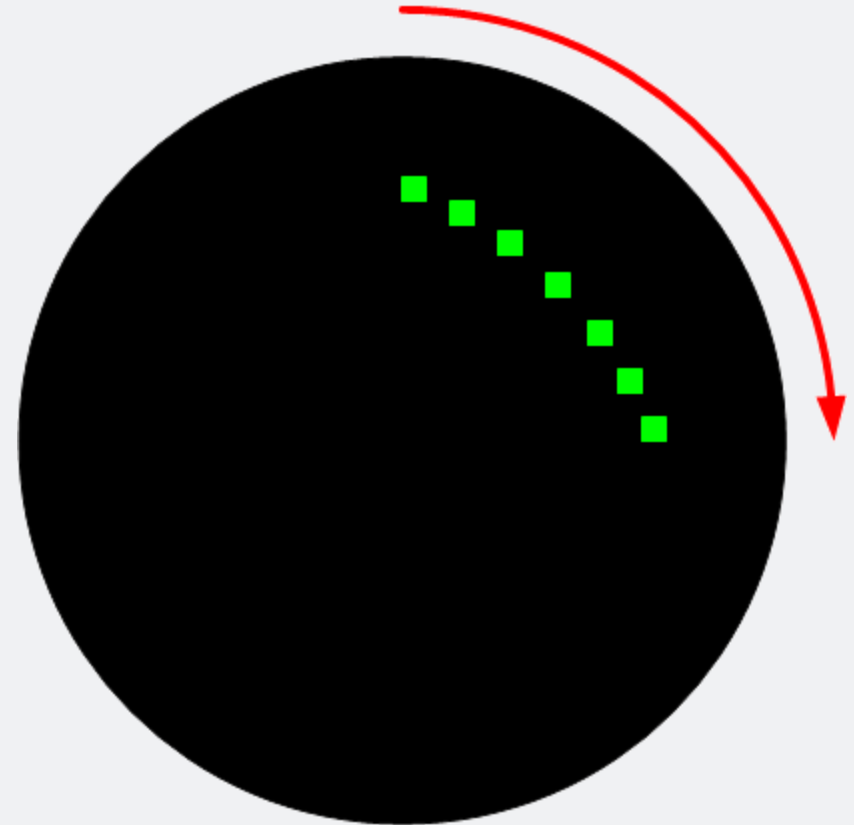

Code (ABCD)/Altitude (x100 Ft) Reporting

- What the operator ultimately sees

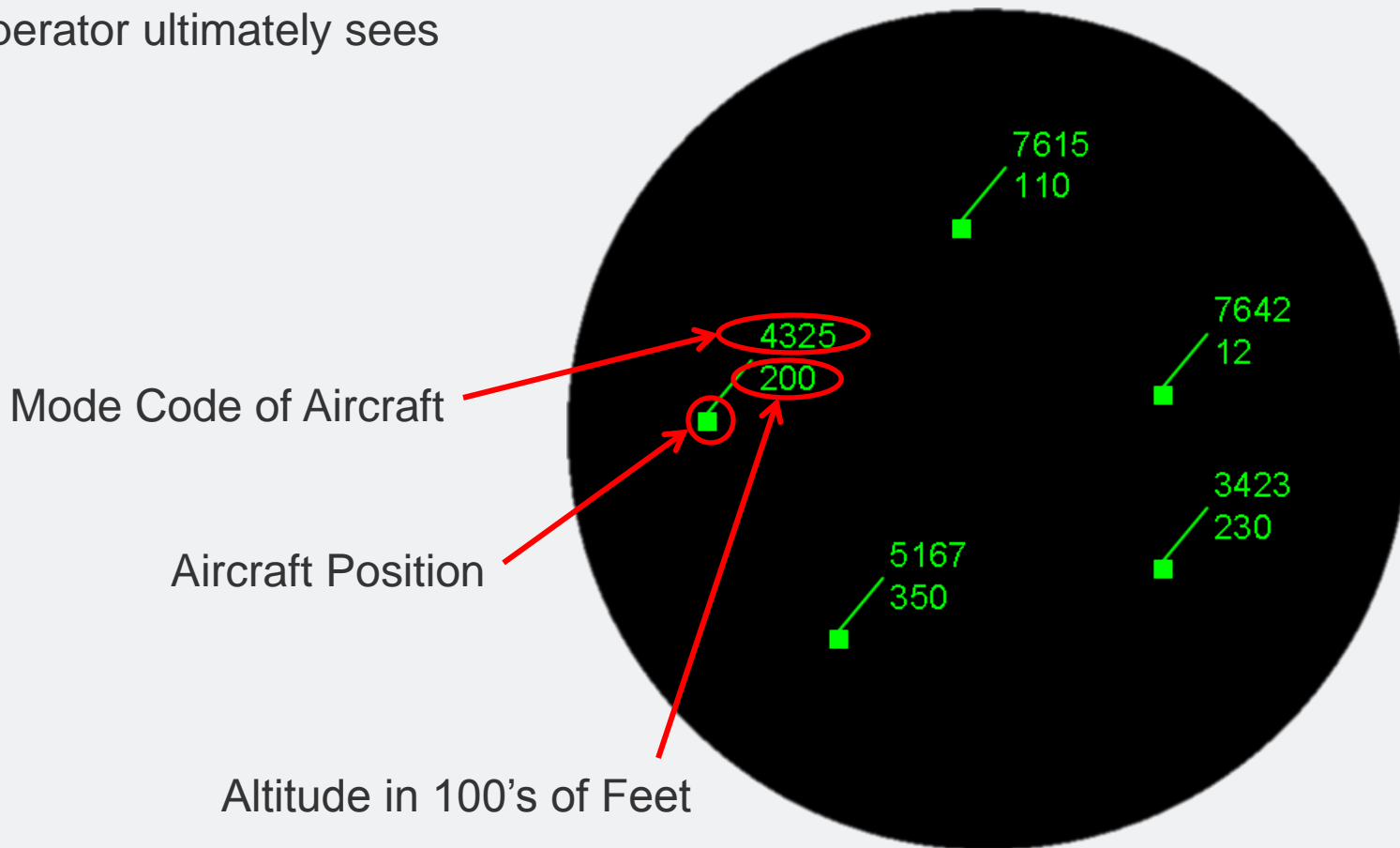

Sidelobe Suppression

Interrogation (P_1, P_3)
Main Lobe

Interrogation (P_1, P_3)
Side/Rear Lobes

Difference Pattern
Area

Sum Pattern
Area

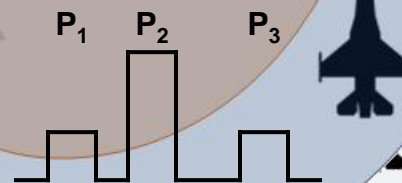
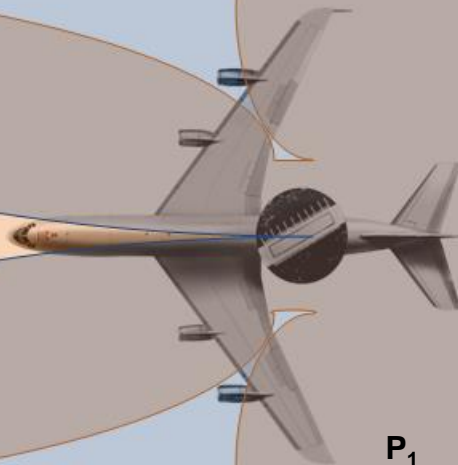
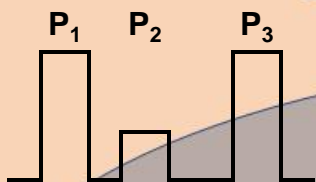

Suppression (P_2)
Lobe

- ISLS: Interrogator SideLobe Suppression
- RSLS: Receiver SideLobe Suppression

Receiver Side Lobe Suppression (RSLS)

- Used to eliminate replies outside of the main beam
- The RSLS K factor (dB) is used to define the region of acceptable replies
 - $\text{RSLS K Factor} = \text{Sum } (\Sigma) - \text{Difference } (\Delta)$
- As the K factor increases, the acceptable region decreases

Interrogation Antenna Pattern Beamwidth

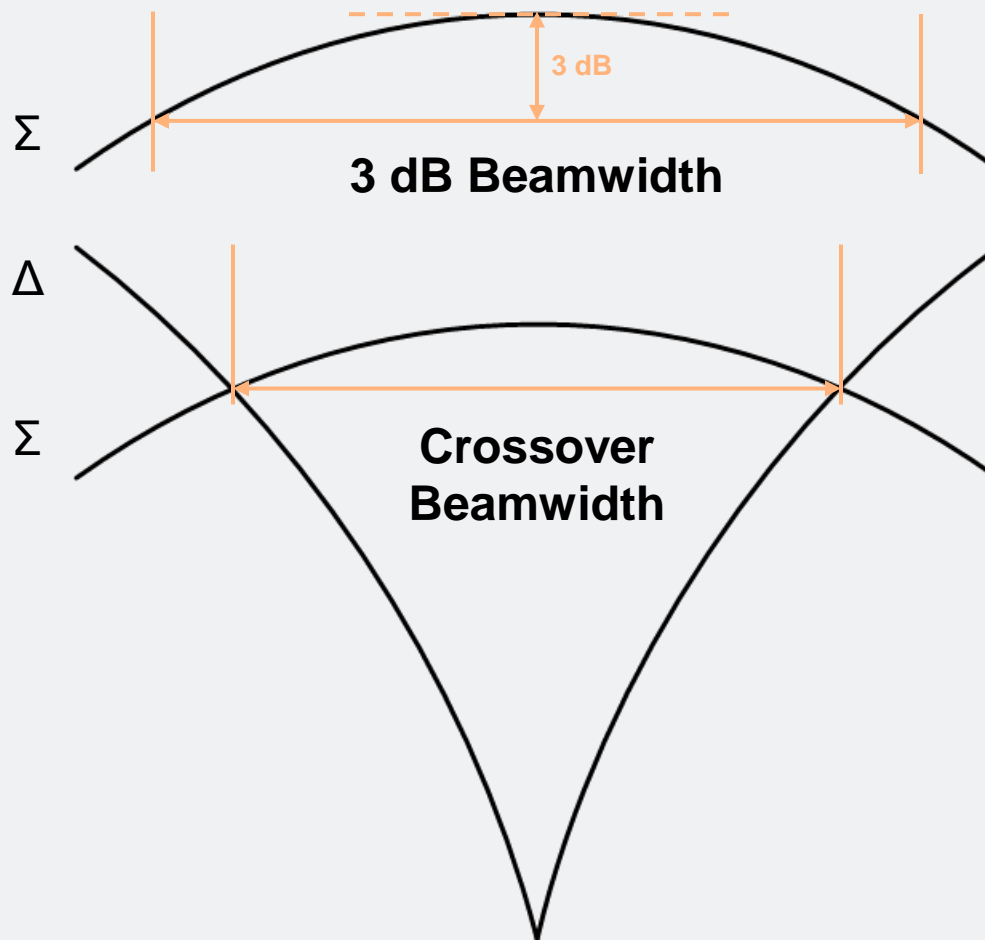

RSLS Processing – Example (K = 9 dB)

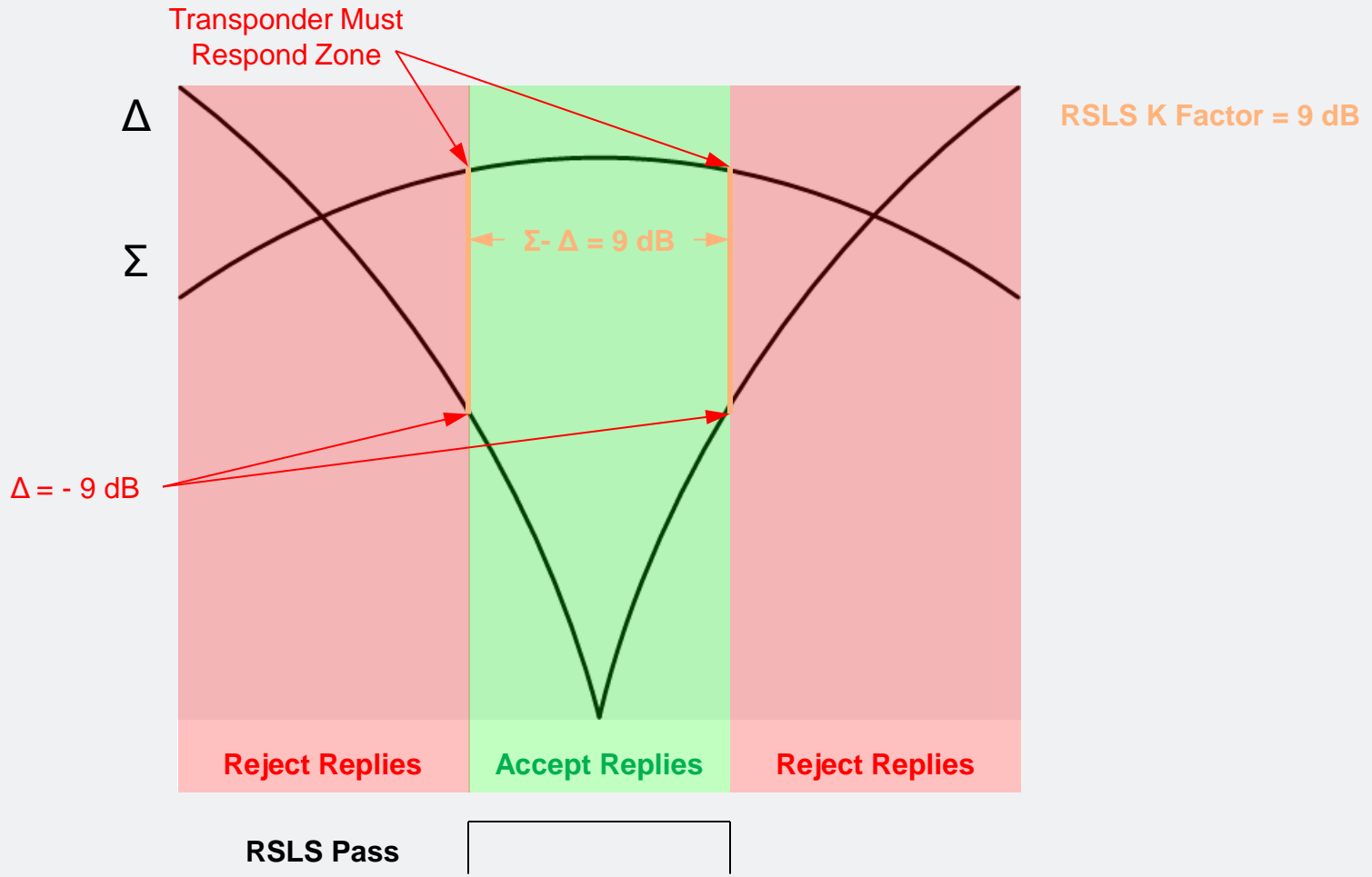

Antenna Dwell Time

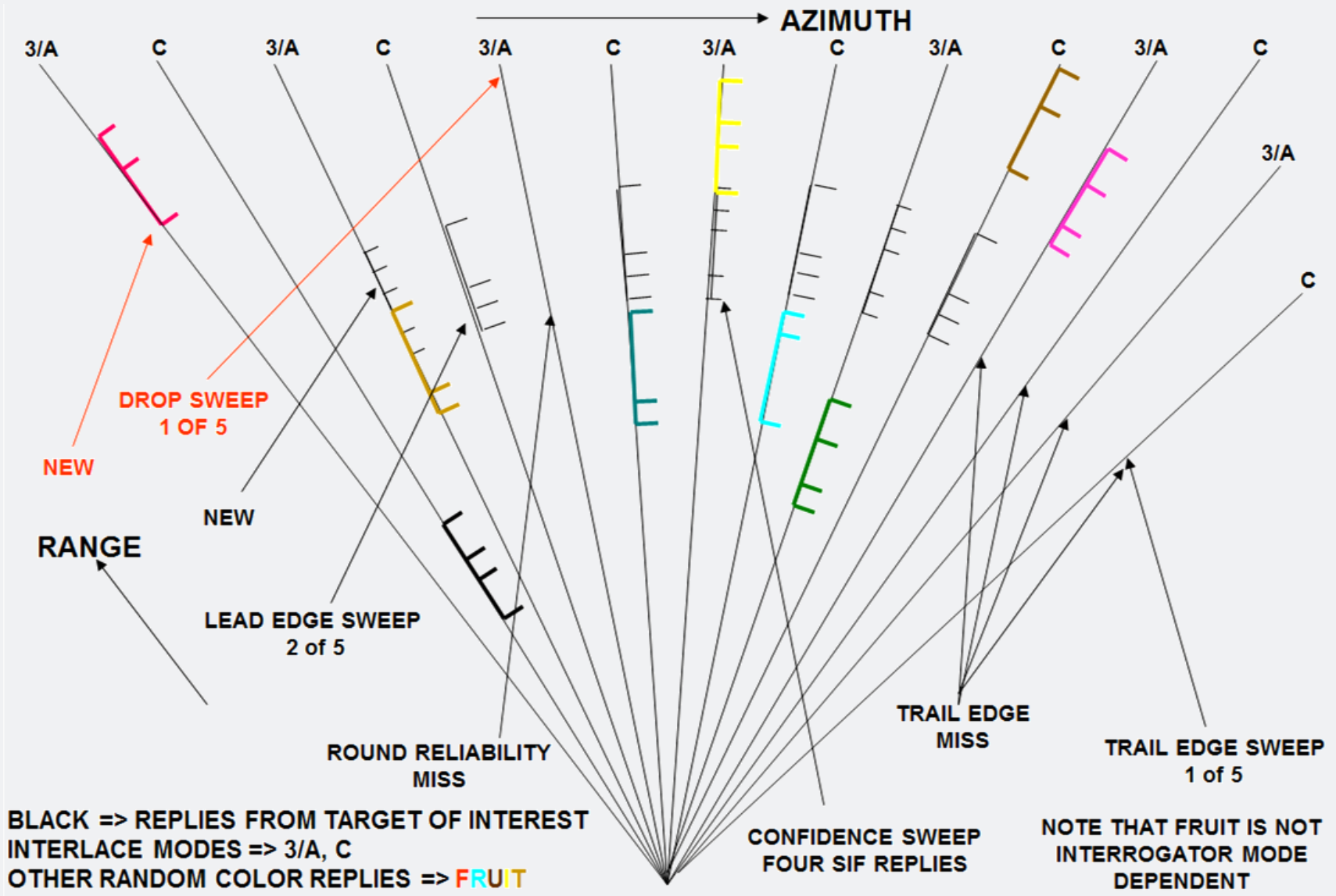

2-Channel Antenna

- Transmit: Sum (Σ) and Difference (Δ) Receive: Σ and Δ
- Azimuth based on Σ and Δ RSLS applied to Σ and Δ
- Δ must provide ISLS coverage
 - To provide higher power side lobes, the main lobe power is lower
 - Lower Δ main lobe power leads to a wider effective beamwidth and poorer azimuth performance

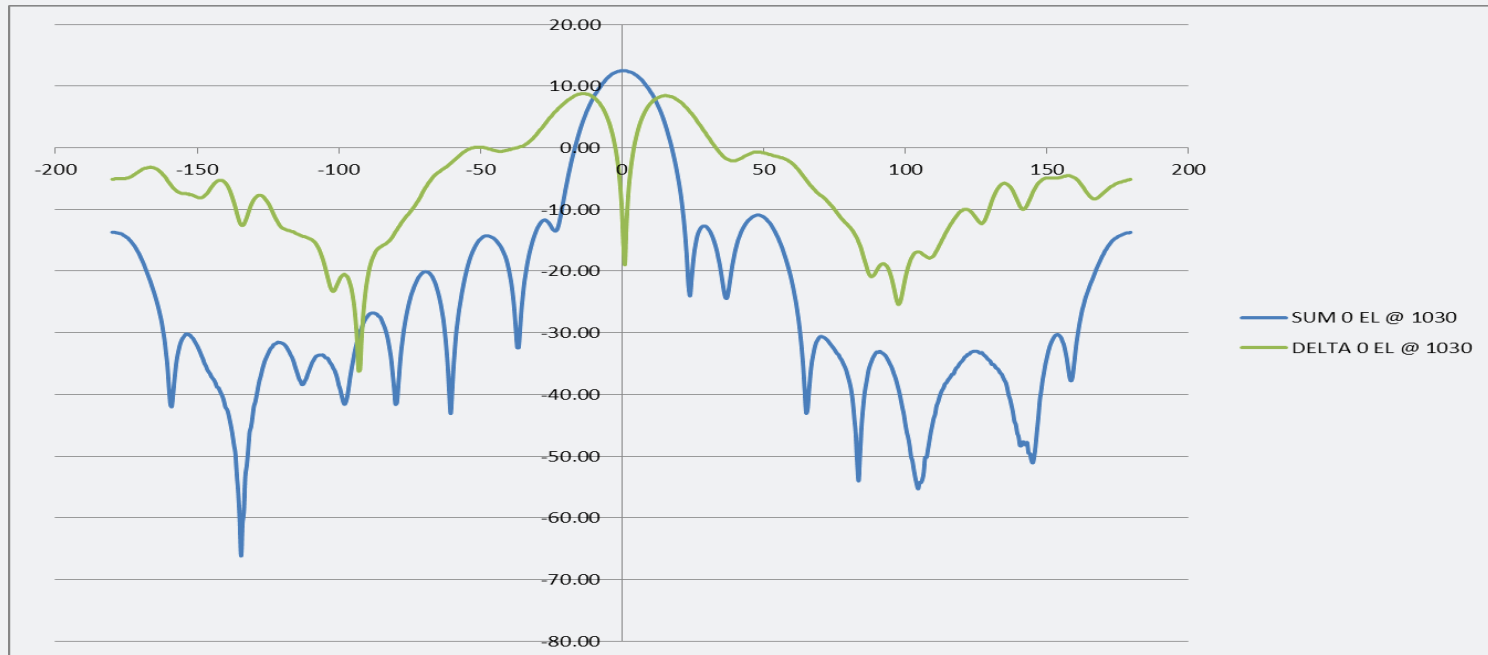

2-Channel Antenna (continued)

- To improve performance, increasing the Δ main lobe power will create a narrower effective beamwidth
 - The negative impact is that this will lower the Δ side lobe power
 - Lower Δ side lobe power creates more punch through/false targets
- How to resolve this issue?

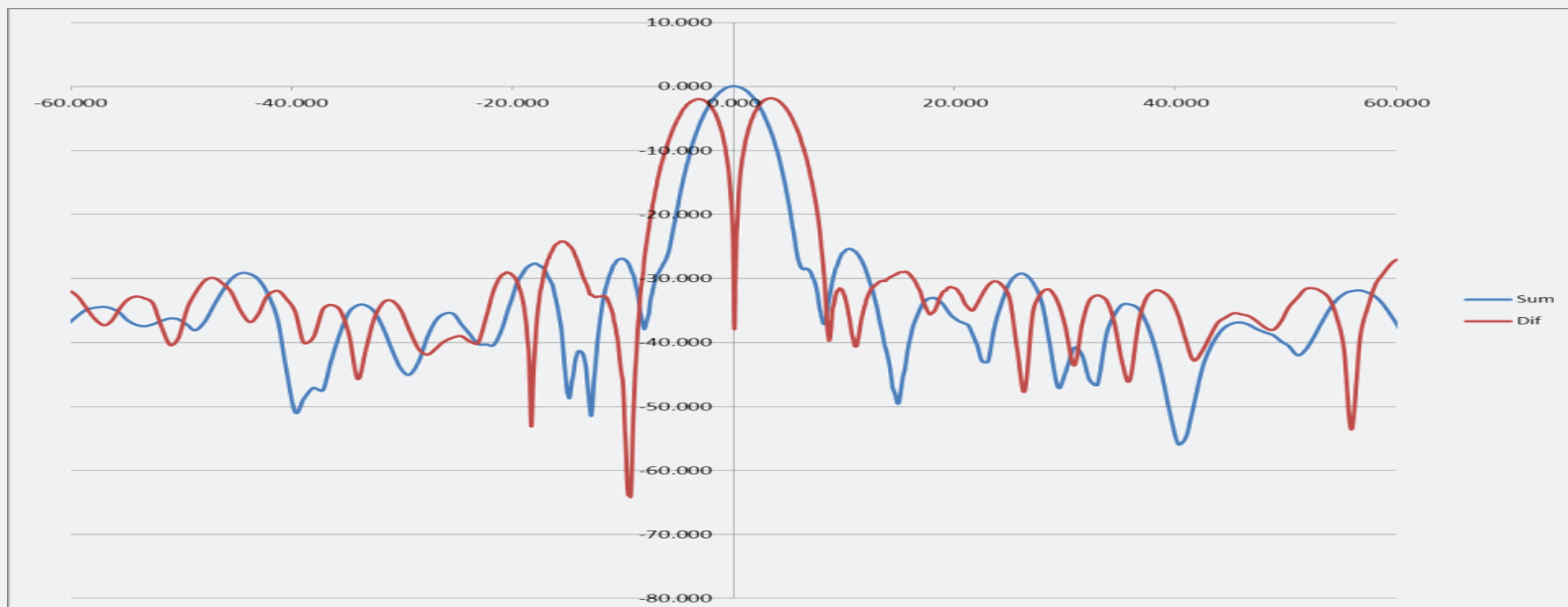

3-Channel Antenna

- Transmit: Σ and Ω
 - Azimuth based on Σ and Δ
 - Must pass both RSLs thresholds to accept replies
 - Ω must provide ISLS coverage
 - Δ main lobes are higher to narrow the effective beamwidth for azimuth performance
- Receive: Σ , Δ , and Ω
RSLs applied to Σ and Δ , Σ and Ω

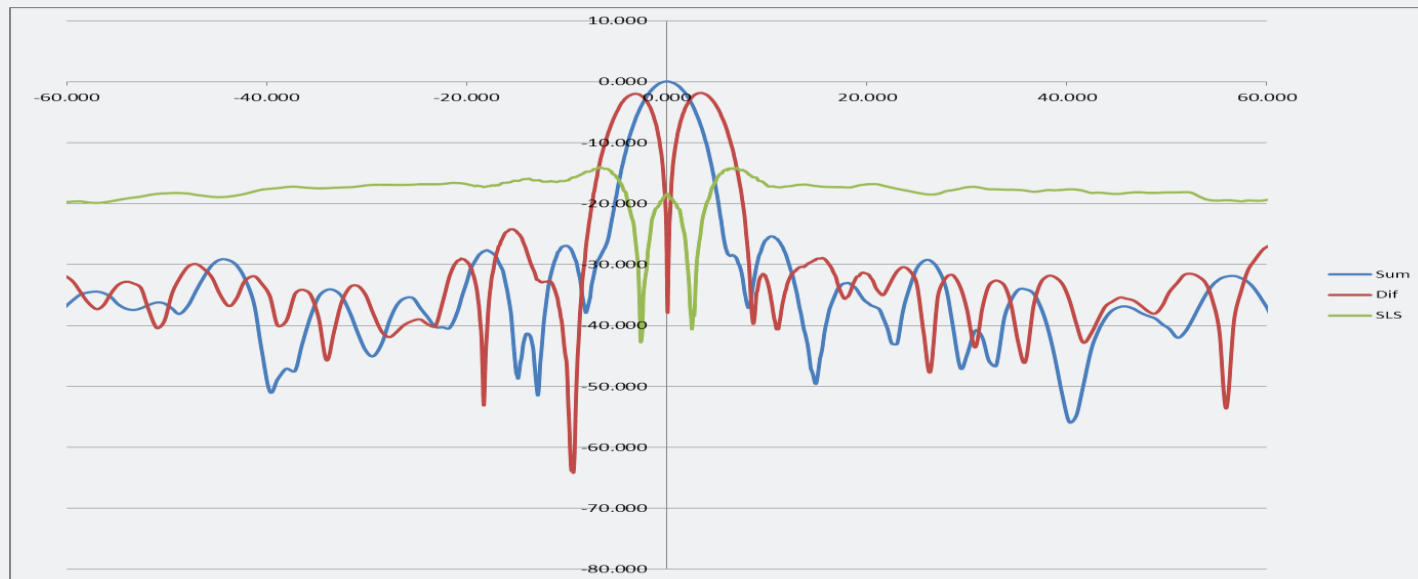

3-Channel LVA IFF Antenna with Backfill

- The Interrogator transmits on Sum and Omni to provide ISLS and receives on Sum, Difference and Omni
 - Sum and Difference are used for monopulse azimuth determination
- Difference and Omni RF level is compared to Sum RF levels for RSLs
 - The 3-channel antenna, and specifically the Omni channel, provides a larger suppression margin, over a 2-channel antenna to protect against false transponders replies in the antenna sidelobe regions
- Poor sidelobe performance from antenna pattern punch-through conditions can be a problem for ATC/IFF display operators and additionally cause unwanted transponder replies
 - The 3-channel Large Vertical Aperture (LVA) antenna greatly reduces false sidelobe target conditions

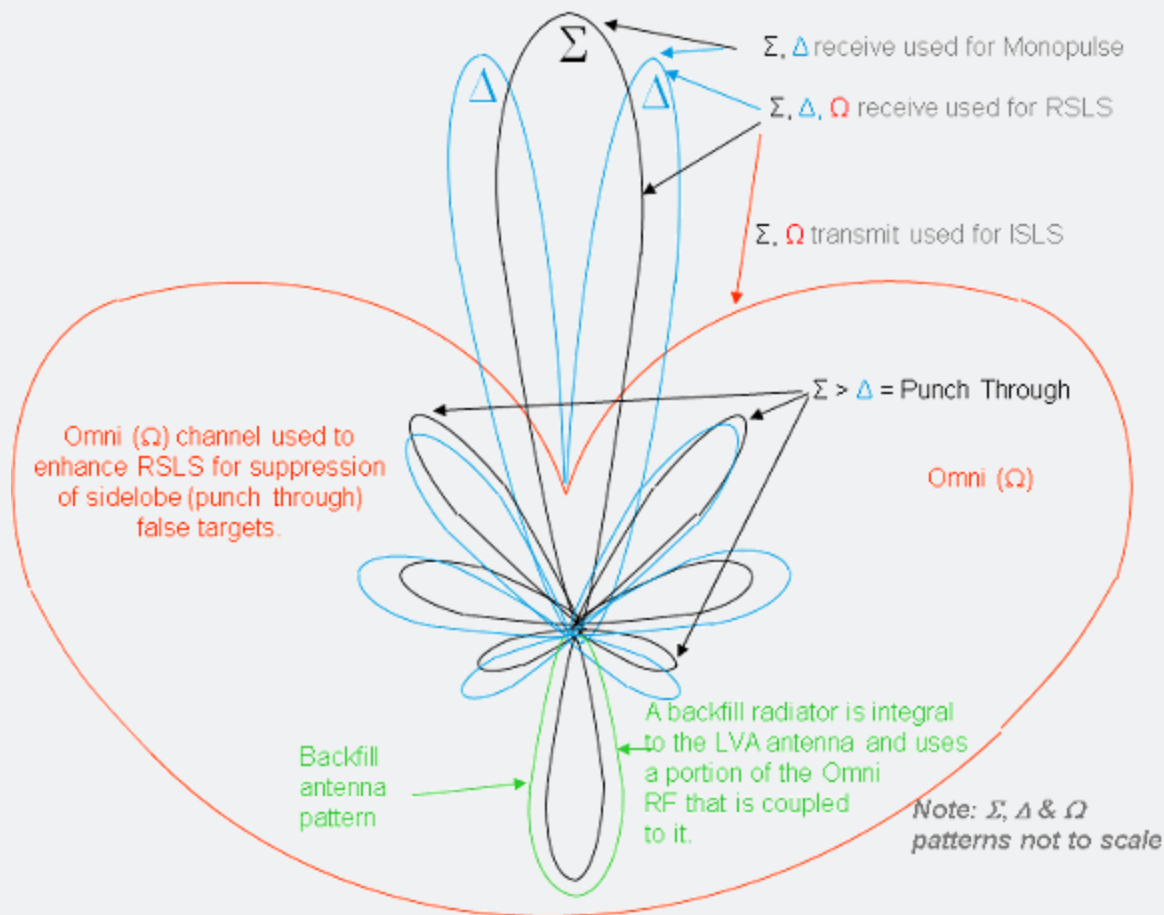

Beamsplit vs Monopulse

- Beamsplit Azimuth Determination (Sliding Window Method)
 - On a scanning beam system, the center azimuth between the first reply and the last reply is the target azimuth
- Monopulse Azimuth Determination
 - Interrogator has the main beam Sum (Σ) and Difference (Δ) pattern relationship in the Off-Boresight Angle (OBA) table
 - Utilizes the received Sum (Σ) and Difference (Δ) RF levels and OBA lookup to calculate the target azimuth
 - Calibration of the input RF signals is required to ensure proper antenna OBA measurement of received replies
 - Multiple azimuth samples are obtained from a target each scan and averaged together to provide a more precise measurement
- The system should automatically revert to beamsplit if monopulse data is deemed non-valid by the monopulse processing algorithm

■ Beamsplit Azimuth Determination (Sliding Window Method)

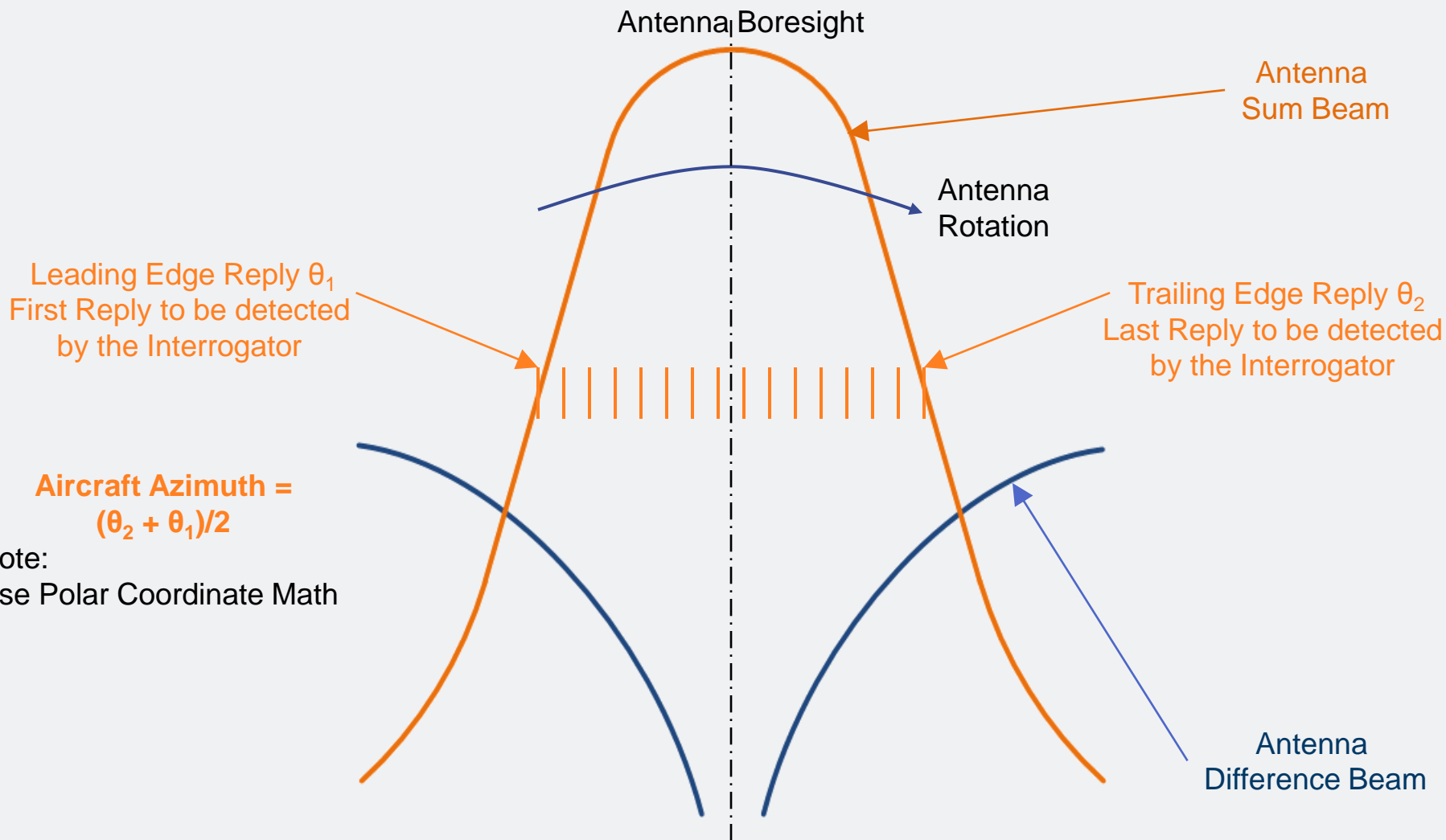

Monopulse

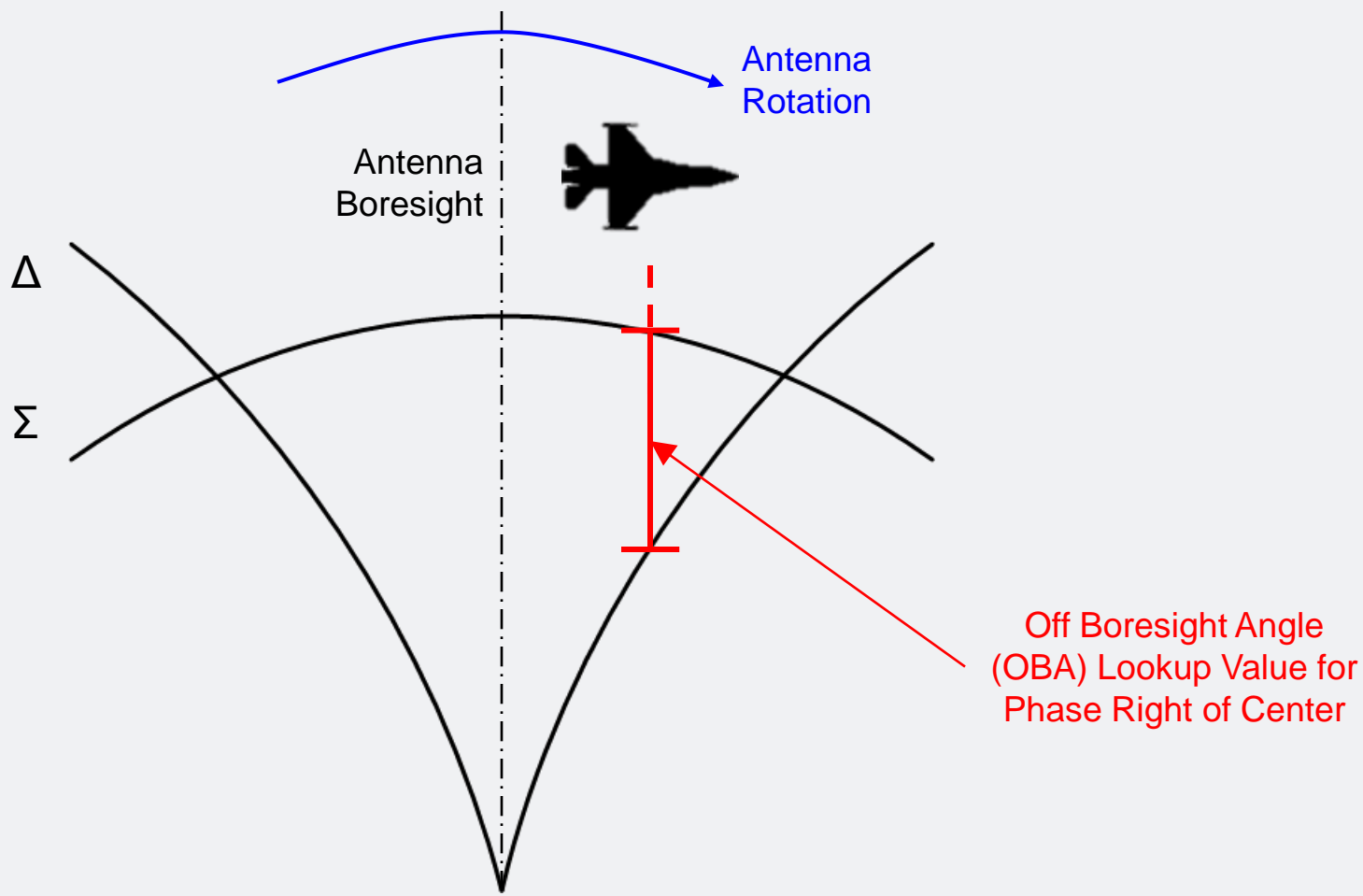

Monopulse, Right of Center

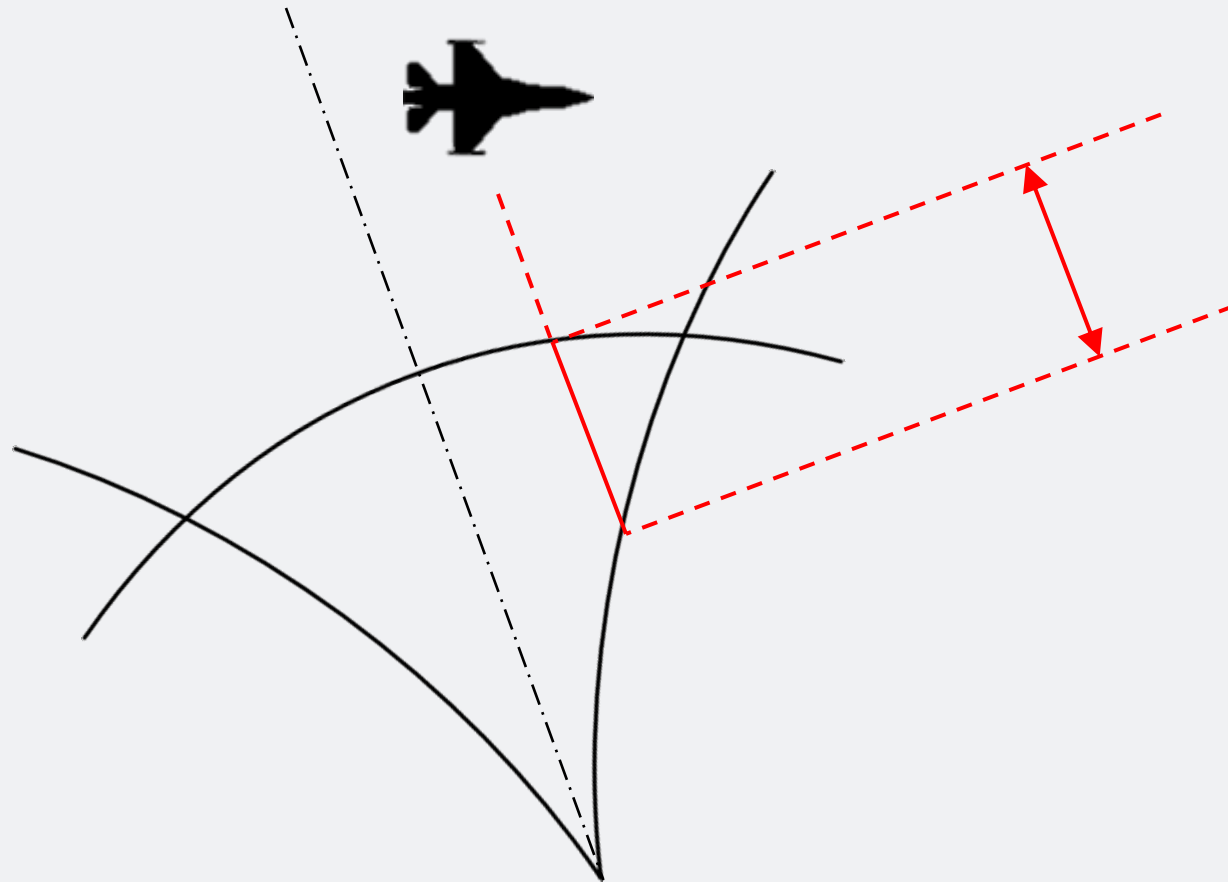

Off Boresight Angle (OBA) = x° Right of Center

Monopulse at Boresight

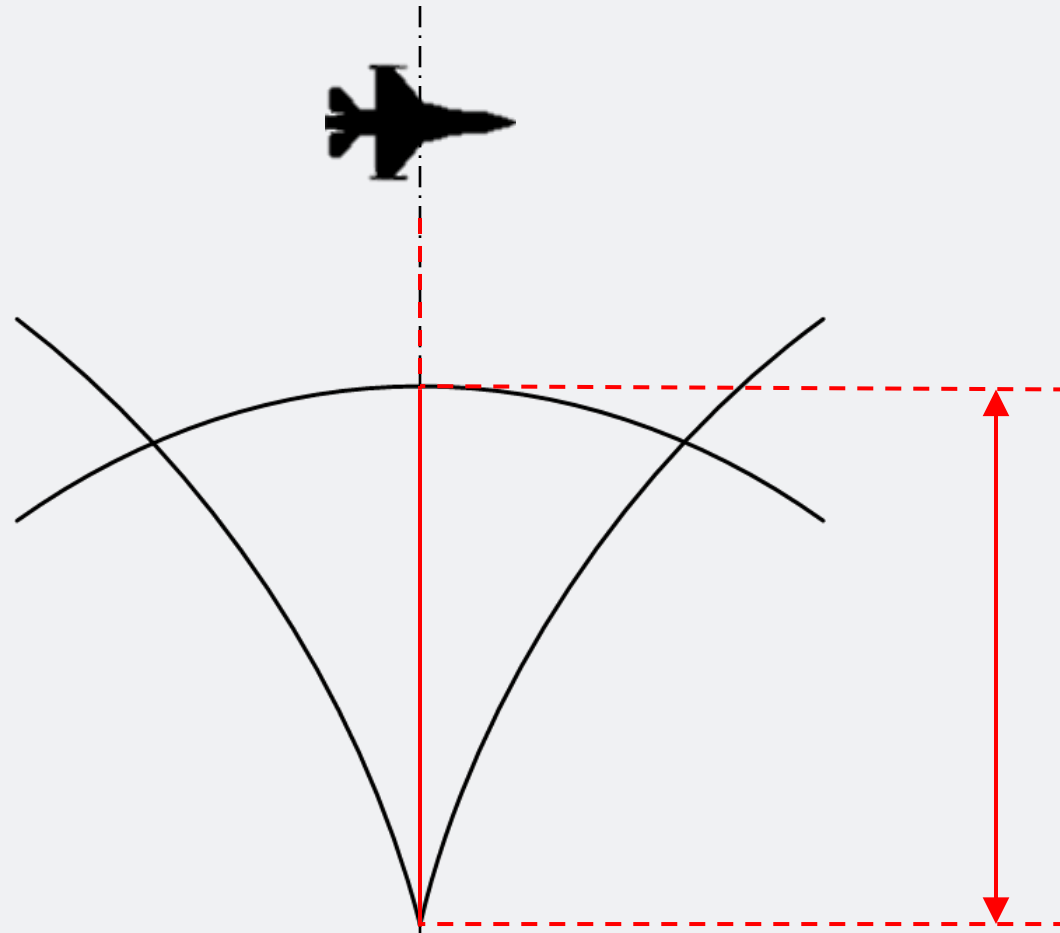

Off Boresight Angle (OBA) = 0° (Center Boresight)

Monopulse, Left of Center

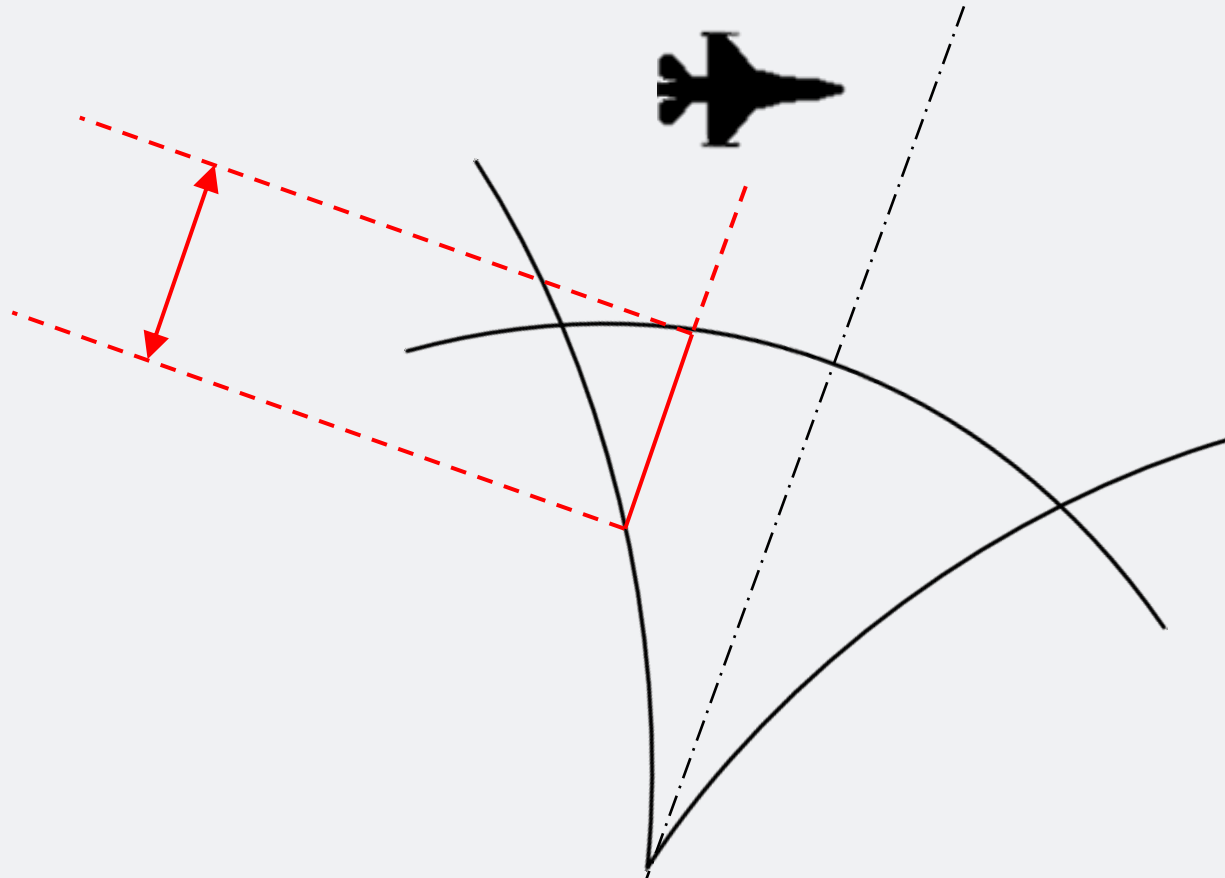

Off Boresight Angle (OBA) = x° Left of Center



RF Link Budgets

RF Uplink Budget Interrogator to Transponder

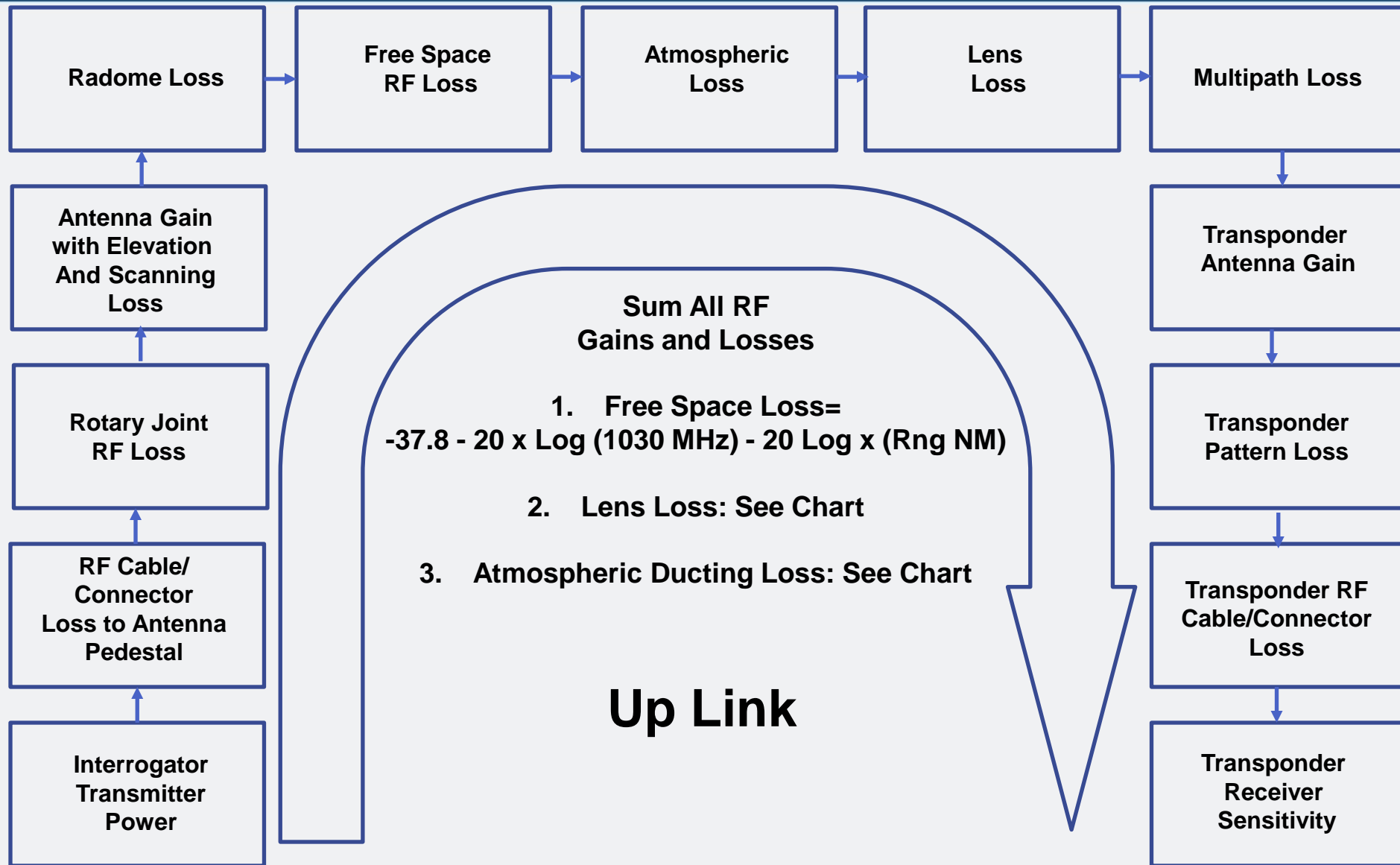

RF Downlink Budget Transponder to Interrogator

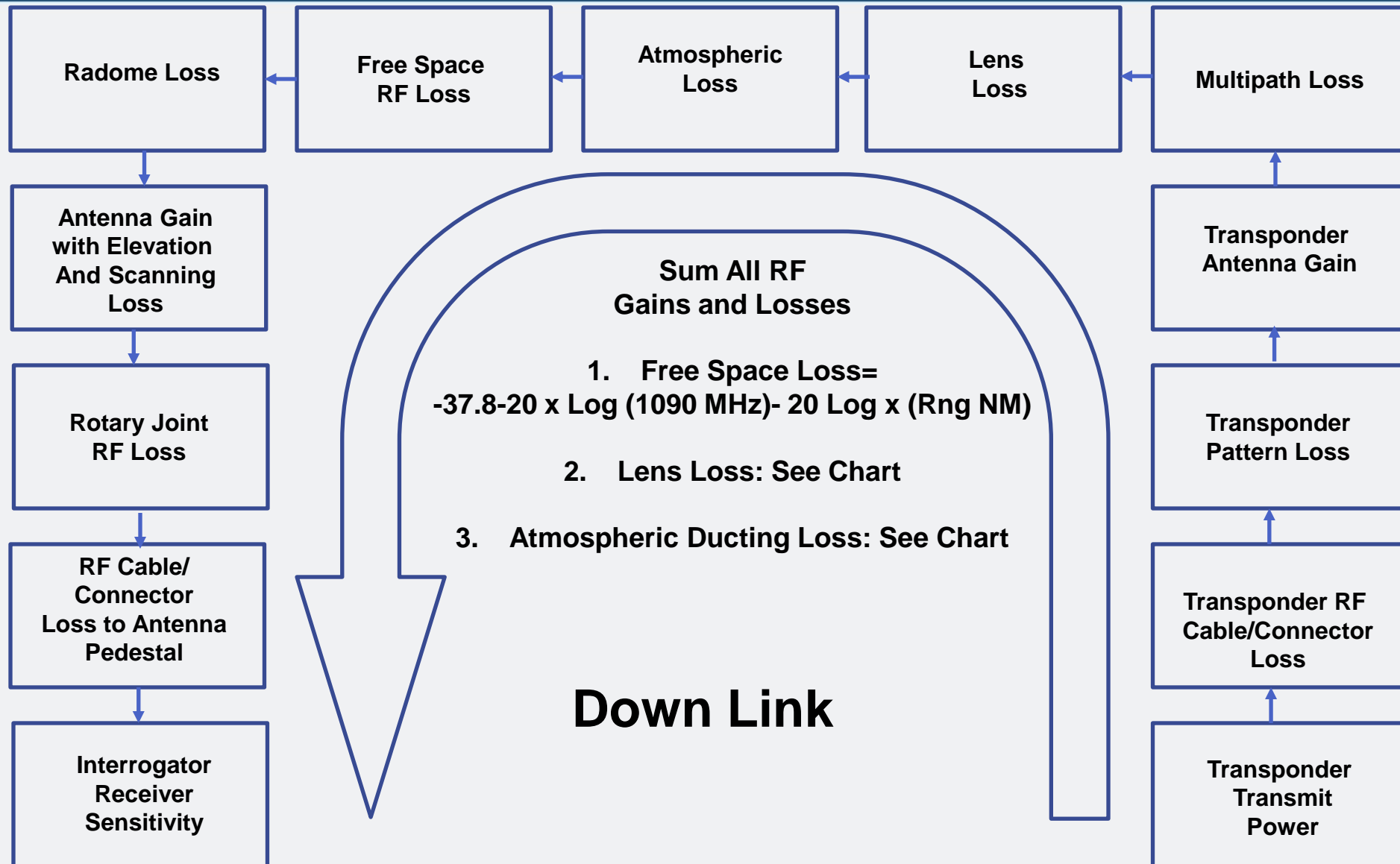

Lens Loss & Atmospheric Absorption Loss

SYSTEM DESIGN

217

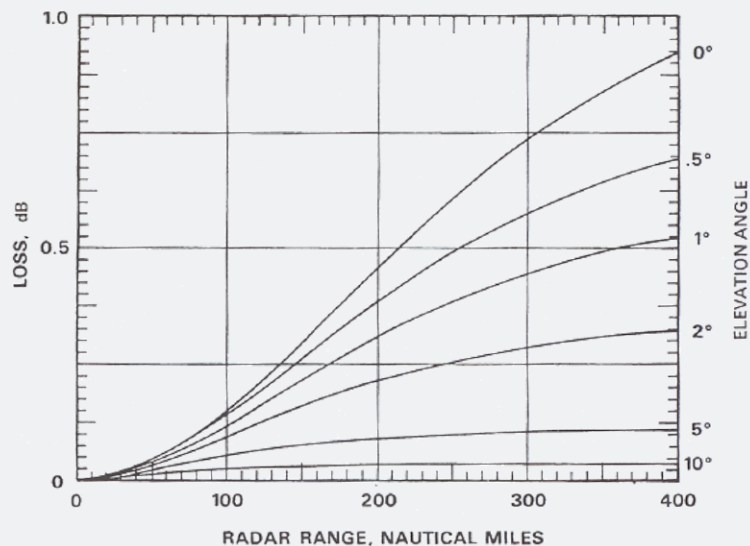

Fig. 10.4 Lens loss for various signal elevation angles (from ref. 10.1).

SYSTEM DESIGN

215

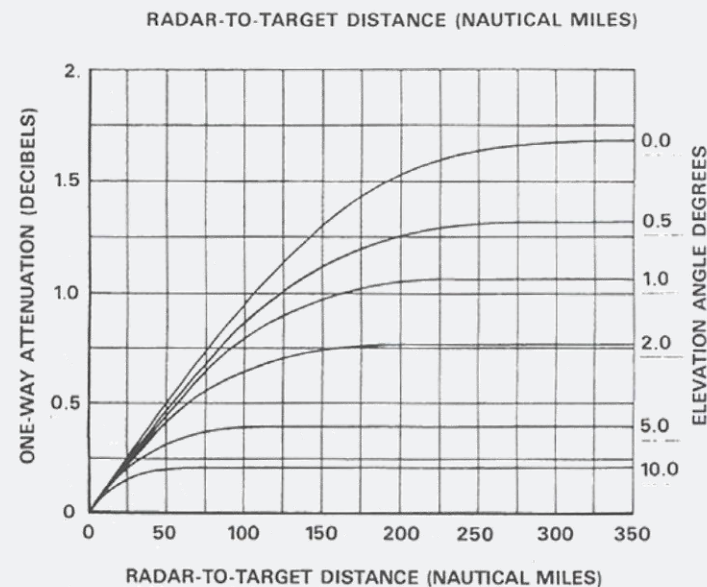

Fig. 10.2 Atmospheric absorption versus range for various signal elevation angles

Up-Link Example

COMMENT	UP-LINK PARAMETER	PARAMETER VALUE	MAXIMUM RANGE (nmi)
2.8kw	Interrogator Power Output (1030 MHz)	64.5	200
Cable & Rotary Joint	Interrogator to Antenna Cable Loss (dB)	-2.5	
	IFF Antenna Gain @ 1030Mhz (dBi)	20.0	
	Radome Loss @ 1030Mhz (dBi)	0.00	
ICAO MAX Limit	Interrogator Ant. ERP (recommended max = 82.5)	82.0	
	Azimuth Scanning Loss (dB)	-2.0	
	Atmospheric/Lens Loss (approx. 0.0065 dB x range)	-1.30	
	Free Space Loss (nmi) @ Max Range: -37.8 - 20Log (1030) - 20Log (Rng nmi)	-144.1	
	Power Level at Transponder Antenna (dBm)	-65.4	
Per STANAG & DoD AIMS	Transponder Antenna Gain (dBi)	0.0	
Per STANAG & DoD AIMS	Transponder Pattern Loss (dB)	0.0	
Per STANAG & DoD AIMS	Transponder Cabling Loss (dB)	-3.0	
	Interrogator Power Level at Transponder (dBm)	-68.4	
Per STANAG & DoD AIMS	Transponder Sensitivity (dBm) Note: -72 dBm = -102 dBW	-72.0	
Plus Value REQUIRED	Total Uplink Margin (dB)	3.6	
Plus Value RECOMMENDED	Using STANAG/DoD AIMS "M" value of 3dB for Long Range Systems	0.6	

Down-Link Example

COMMENT	DOWN-LINK PARAMETER	PARAMETER VALUE	MAXIMUM RANGE (nmi)
Per STANAG & DoD AIMS	Transponder Power Output (dBm)	55.0	200
Per STANAG & DoD AIMS	Transponder Cable Loss (dB)	-3.0	
Per STANAG & DoD AIMS	Transponder Antenna Gain (dBi)	0.0	
Per STANAG & DoD AIMS	Transponder Pattern Loss (dB)	0.0	
	Atmospheric/Lens Loss(aprox. 0.0065 dB x range)	-1.30	
	Free Space Loss @ Max Range: -37.8-20Log (1090) - 20Log (Rng nmi)	-144.6	
	Antenna to Interrogator Cable Loss	-2.5	
	Radome Loss	0.0	
	Power Level at Interrogator Antenna	-96.4	
	Interrogator Antenna Gain @ 1090Mhz (dBi)	20.0	
Can be Lowered by Adjusting RSLs K Factor	Azimuth Scanning Loss (dB)	-2.0	
	Transponder Power Level at Interrogator Input (dBm)	-78.4	
	Interrogator Receiver Sensitivity	-82.0	
Plus Value REQUIRED	Total Downlink Margin (dB)	3.6	
Plus Value RECOMMENDED	Using STANAG/DoD AIMS "M" value of 3dBfor Long Range Systems	0.6	

Line of Site (LOS) Coverage Due to Earth Curvature

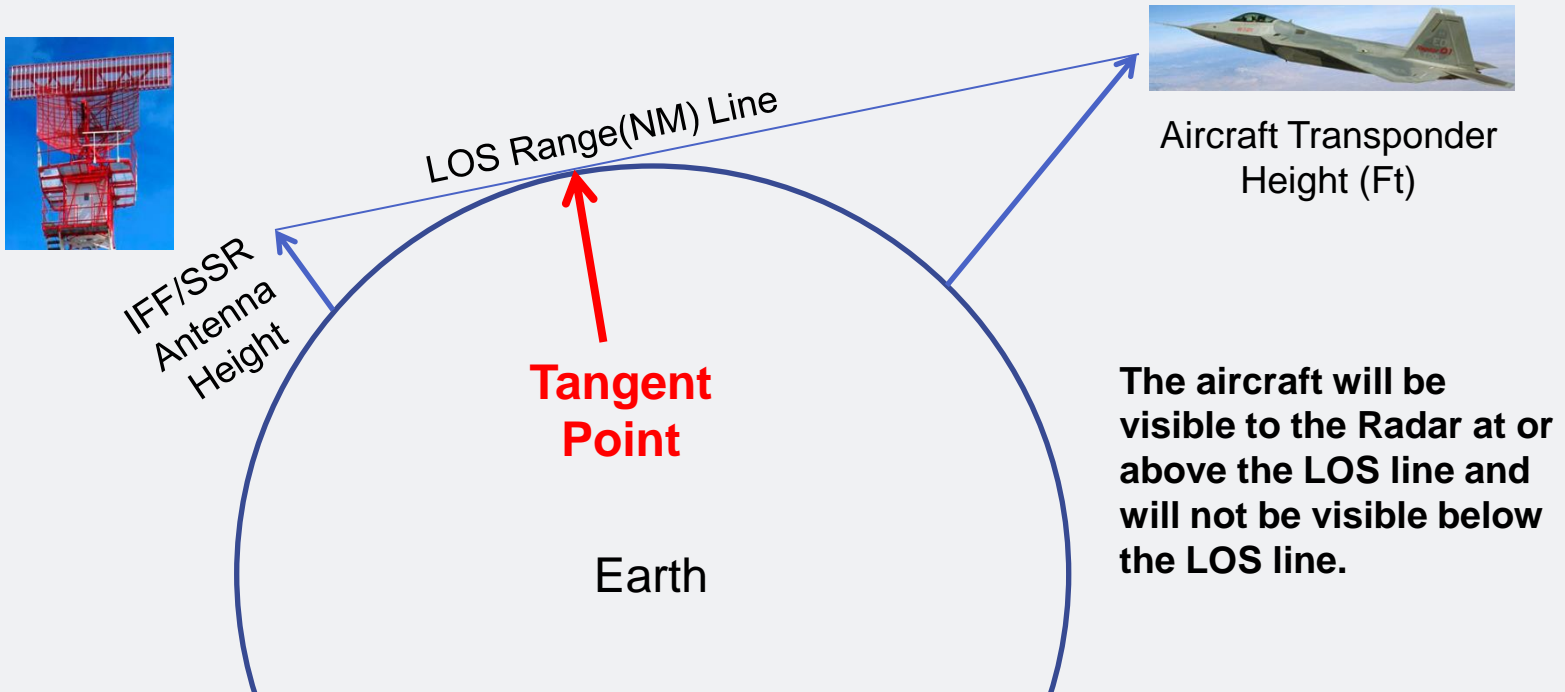

The aircraft will be visible to the Radar at or above the LOS line and will not be visible below the LOS line.

Example:
Target Height = 40,000ft
Radar Height = 100ft
LOS = 262.25 nm

$$\text{LOS Range (NM)} \approx 1.25 \times \sqrt{\text{Target Height(ft.)}} + 1.25 \times \sqrt{\text{Radar Height(ft.)}}$$



Part II

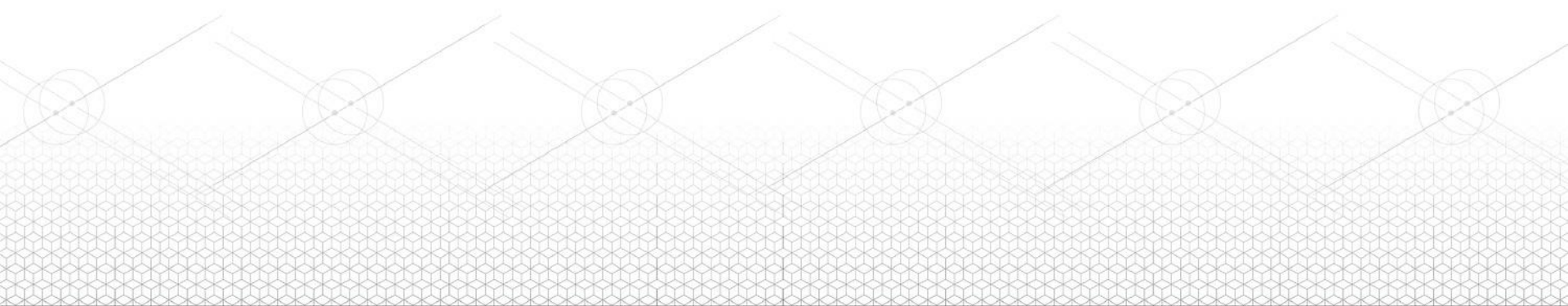



Description of SSR/IFF Modes

- IFF/SSR is a two-frequency system, with one frequency (1030 MHz) used for the interrogating signals, and another (1090 MHz) for the reply
- The Military designated IFF Modes 1, 2, 3, 4 and 5
- The Civil ATC designated SSR Modes A, B, C, D and S
- Military Mode 3 and Civil Mode A are identical waveforms used by both Military IFF and Civil ATC, and is designated as Mode 3/A
- The system is broken down into nine modes (1, 2, 3/A, B, D, C, S, 4 and 5) of operation for military and civilian aircraft (Modes B and D are non-standard and will not be discussed)
 - Mode 4 is no longer approved for US/NATO Military use and will not be discussed
 - Mode 5 is used as a military secure mode replacing Mode 4
- FAA regulations require all aircraft, military or civilian, flying at an altitude of 10,000 feet or higher in controlled airspace, must be equipped with an operating IFF/SSR transponder system capable of automatic altitude reporting (Mode C)
- Each Interrogation Mode elicits specific information from the aircraft being challenged
- Non-Solicited Transponder Squitter Reports are provided by Mode S ADS-B, UAT, Mode 5 Level 2 and Level 2B

- Legacy Mode 1 uses 5 bits, provides 32 reply codes, and is traditionally used in military air traffic control to determine the aircraft type, or mission type
 - Currently an Extended Mode 1 is available providing 12 bits (4096 codes)

- Mode 2, also used by the military, and traditionally is used to identify a particular aircraft
 - There are 4096 possible reply codes in Mode 2

- Mode 3/A is the standard ATC/IFF mode and is used internationally, in conjunction with Mode C altitude request to provide positive control of all aircraft flying under Instrument Flight Rules (IFR)
 - Aircraft are assigned unique Mode 3/A codes by the airport departure controller. General aviation aircraft flying under visual flight rules are not under constant positive control, and such aircraft use a common Mode 3/A code of 1200. In either case, the assigned code number is manually entered into the transponder control unit by the pilot or a crew member

- Mode C is an automatic altitude reporting capability for aircraft
- Mode B and Mode D have limited or no use
- Details of Modes B and D will not be covered in this brief
- Mode 4 was the original cryptographic secure mode used by the military, and has been replaced by Mark XIIA (Mode 5)
- Mode 5 or Mark XIIA is the new military IFF secure mode
 - Mode 5 resolved many of the operational and performance issues with Mode 4
- The group of modes 1, 2, 3/A and C are referred to as Selective Identification Feature (SIF) Modes

Waveforms

INTERROGATOR
 Transmitter: 1030 MHz
 Receiver: 1090 MHz
 Interrogation

TRANSPONDER
 Transmitter: 1090 MHz
 Receiver: 1030 MHz
 Reply

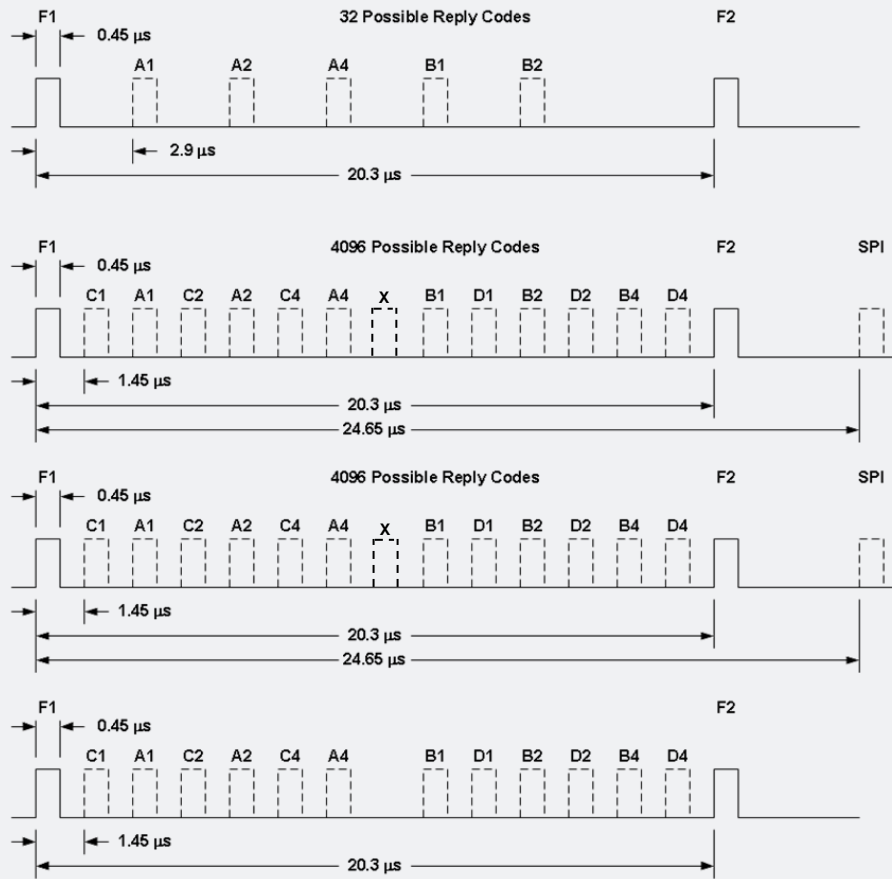
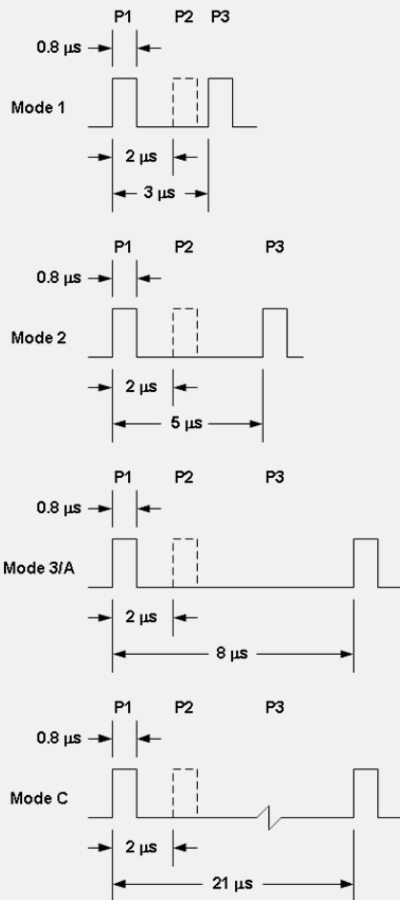

Mode 1:
 Military aircraft type
 or mission indicator

Mode 2:
 Military identification
 code

Mode 3/A:
 Beacon code

Mode C:
 Pressure altitude of
 aircraft

P1-P3 Note: Mode B = 17μs and Mode D = 25μs

Special Indicators

- Special Position Indicator (SPI)
 - When requested by the air traffic controller to ‘ident’, the identity control is activated and the SPI bit from that transponder is set for ≈ 18 seconds
 - The transponder is then highlighted on the air traffic controller’s display for identification confirmation
 - Mode 1 SPI is 2-F1/F2 brackets separated by $24.65\mu\text{s}$
 - Mode 2 and 3/A SPI pulse is positioned $4.35\ \mu\text{sec}$ after the F2 pulse enabled by the “identify control” on the transponder in the aircraft cockpit when requested by air traffic control to “Squawk Ident”
 - Mode S transponders also provide a SPI capability
- Emergency Codes and Conditions
 - 7500 (Hijack), 7600 (Communication Failure) and 7700 (Emergency)
 - 4-F1/F2 Bracket Military Emergency in Mode 2 & 3/A separated by $24.65\mu\text{s}$
- X-Pulse (XP)
 - Indication of special aircraft, may be used for drones
 - Traditionally the X-Pulse was used to identify Bomarc missiles

Mode S Introduction

- Nearly 100 % of commercial traffic are currently using Mode S transponders
- Mode S Transponders are becoming a requirement for unrestricted air space
- Needed for Collision Avoidance
- Europe required basic surveillance
- Europe required enhanced surveillance
- US reviewing Home Security and Defense applications

Mode S Benefits and Strategy

- Benefits of Mode S
 - Roll-calls: Since each target can be individually (selectively) addressed, there is less chance of garble
 - All-Calls: Once acquired and lock-out is maintained, a Mode S target will not reply to all-calls from that II code
 - Reduces “RF pollution”
 - Reduces “transponder occupancy” (improves transponder’s availability to reply to others)
- Additional Mode S Strategies (partial list)
 - Stochastic Acquisition: Interrogations can be coded such that transponders are asked to respond to all-calls at a lower probability-of-reply, helping to reduce the chance of garble for closely spaced targets.
 - Lockout Override: Interrogations can be coded such that transponders are forced to respond to all-calls, even if they are locked out (Typically used with II code 0)

Waveforms

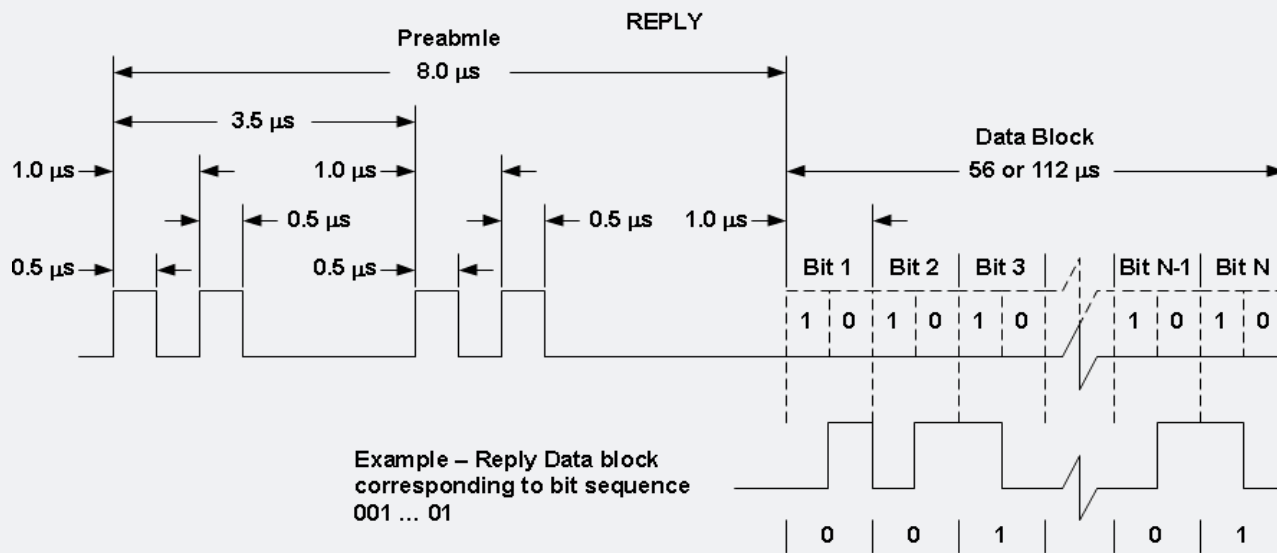
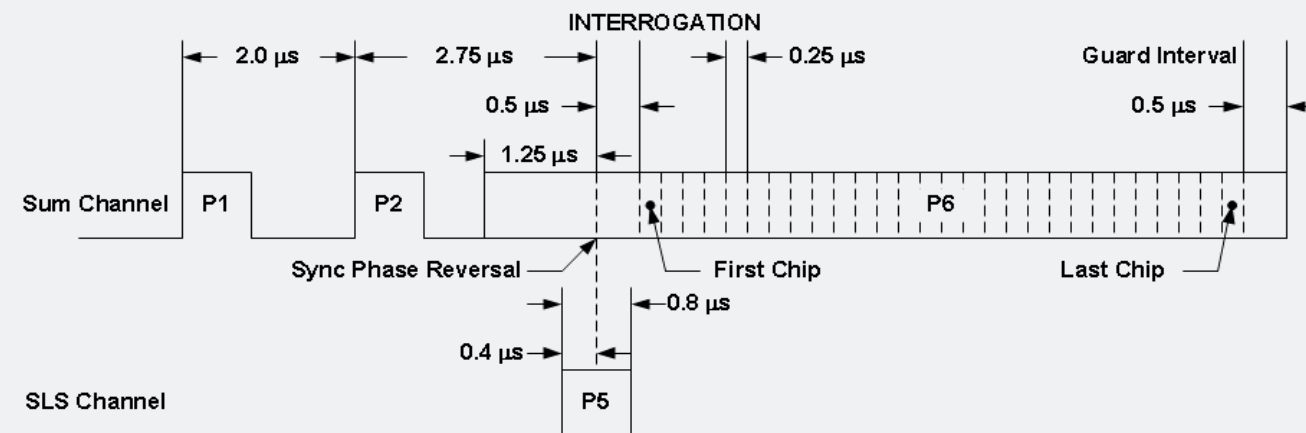

Capabilities

- Mode S is an enhancement of the "classic" Secondary Surveillance Radar.
- Mode S overcomes many of the current limitations as well as offering additional capabilities.
- Mode S permits selective addressing of individual Mode S transponder equipped targets.
- Each Mode S target is equipped with a unique ICAO 24-bit address that must be acquired by the Mode S Interrogator prior to the Selective Addressing process.
- The Interrogator uses a Mode S All-Call (all target broadcast) Interrogations to acquire Mode S addresses.
- Mode S adds a data link capability between a Mode S target and a Mode S Interrogator once the Interrogator acquires the target:
- Selective Interrogations are sent from the Mode S Interrogator to the target of interest
- Downlink Aircraft Parameters (DAPS) are sent from the target to the Interrogator
- Mode S Transponder data link capability and DAP support of an individual platform
- Must be determined by the Interrogator to initiate data link transfers
- The Mode S Interrogator uses Mode S Roll-Call interrogations to selectively address targets and to set up the selective data link.

Capabilities (continued)

- Interrogator Codes
 - 15 II-codes; 63 SI codes; II = “0” typically reserved for mobile interrogators
- Selective Addressing
 - ICAO aircraft address is 24-bits (over 16 million possible codes)
- Acquisition and Lockout
 - IC field included as part of all interrogations and replies
 - Interrogators typically perform “All-Calls” interrogations to accomplish initial acquisition of targets
 - Once acquired, surveillance is maintained by subsequent “roll-calls” that individually address each Mode S target
 - As each target is addressed, it can be “locked-out” from responding to any subsequent “all-calls” from that specific Interrogator (based on its Interrogator Code)
 - Transponders keep track of which interrogators have locked them out
 - Lock-out duration is 18 seconds

Mode 5 Introduction

- Mode 5 provides significant operational and performance improvements over Mode 4

- Mode 5 defines four operational levels using two waveform classes:
 - L1, Q&A: a synchronous (triggered by interrogations) mode with Processing Gain
 - Level 1 is similar to Mode 4 Q&A but is enhanced with an Aircraft Unique PIN
 - L2, *Position Reporting*: an asynchronous (triggered and non-triggered) mode with Processing Gain & includes additional information such as Aircraft Position and Other Attributes
 - L3, *Selective Interrogation*: a synchronous or asynchronous mode (Future Use)
 - L4, *Extended Data*: an asynchronous mode with High Data rate (Future Use)

- Mode 5 uses Enhanced Encryption, Spread Spectrum Modulation, and Time of Day Authentication.

Mode 5 Introduction (continued)

- Mode 5 is specified in NATO STANAG 4193 and DOD-AIMS 17-1000
- Assures interoperability between allies and coalition forces
- Mode 5 related COMSEC specification and interface control documents detail the new cryptographic algorithm and the time-dependent authentication and data encryption features
- The DoD AIMS Program Office Certifies IFF Systems to Ensure Interoperability

Mode 5 Adresses Mode 4 Deficiencies

- Mode 5 has replaced Mode 4 as a new crypto-secure military identification system

- Mode 5 provides:
 - High-confidence identification of friendly air, ground, and surface targets in target-dense scenarios
 - Situational awareness without latency using GPS/INS position reporting
 - Secure data transfer between platforms

- Mode 5:
 - Has private-channel capability
 - Increases identification range
 - Reduces operator work load
 - Reduces interference to civil ATC

Operational Objectives and Benefits

- Prevent fratricide through high confidence, accurate, continuous, friendly identification
- Provide Positive & Improved Identification at and Beyond Maximum Weapons Engagement Range
 - Extends effective coverage
 - Reduces target drop outs
 - Reduces track swaps
 - Eliminates Mark XII weakness
- Increase reaction times by providing higher quality long range identification
- Separate closely spaced targets in a single scan
 - Eliminates leader squawk procedures
 - Eliminates related track swap
- Provide modern day security
- Be compatible with civil Air Traffic Control (ATC)
- Be interoperable with NATO/allies

Interrogation Waveform

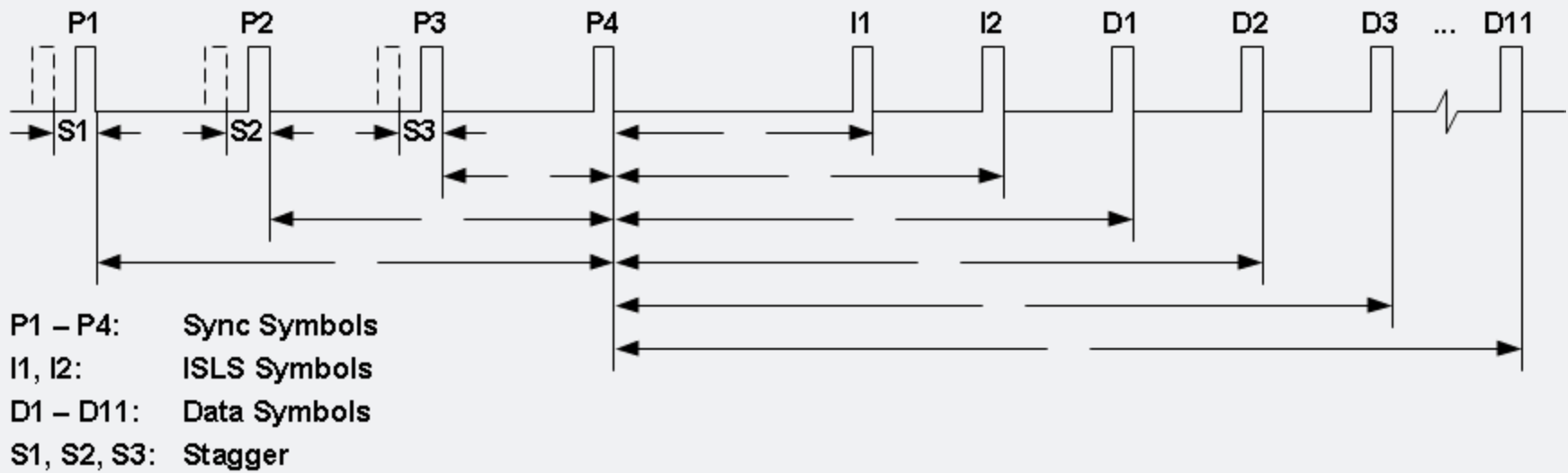

Reply Waveform

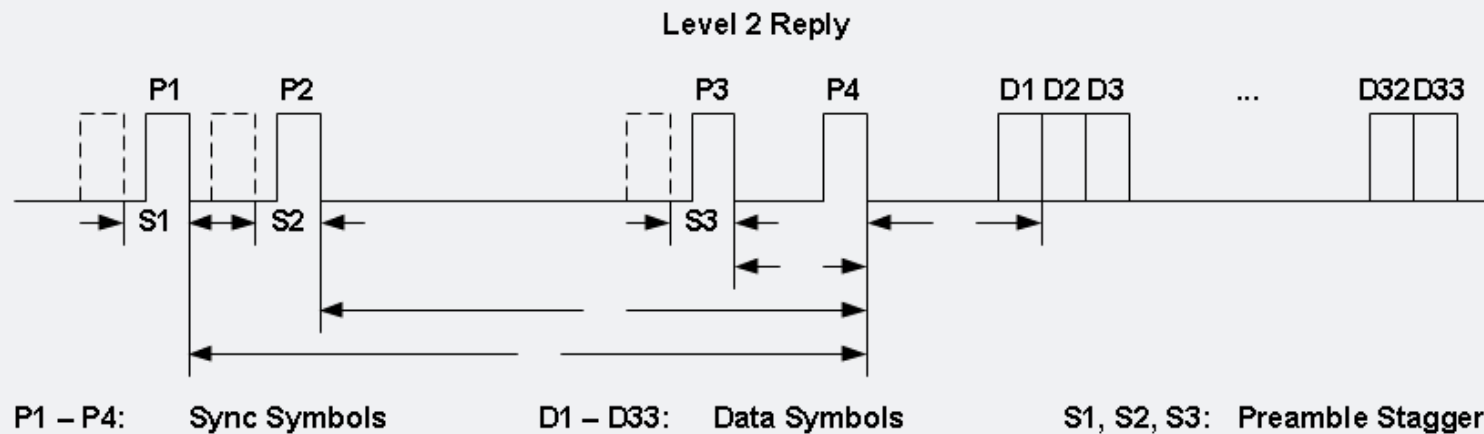
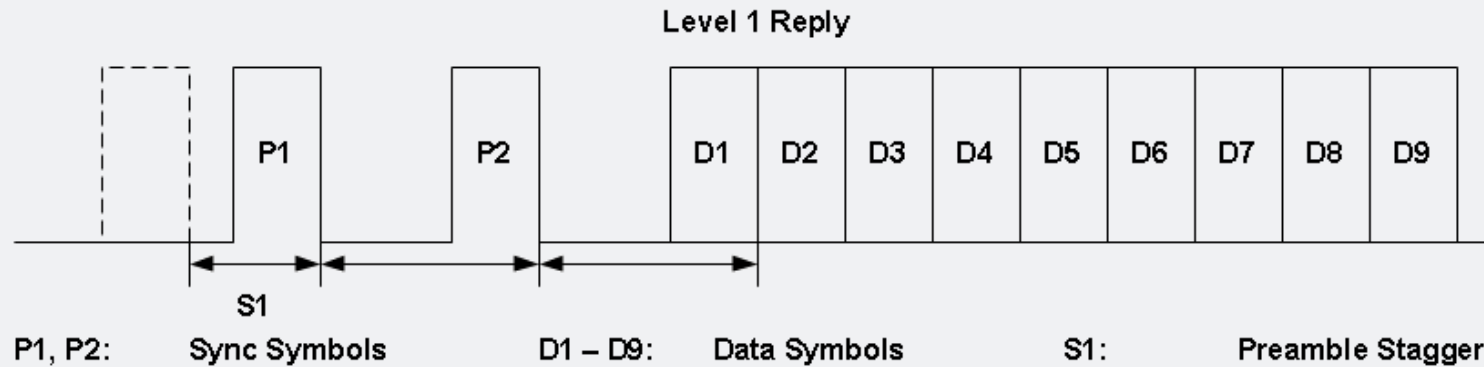

Formats

Level	Format	Data Requested	Inputs Required
1	0	ID	Valid Crypto Keys and Time
1	1	Mode 1, 2 Codes	Valid Crypto Keys and Time
1	2	Mode 3/A, C Codes	Valid Crypto Keys and Time
1	3	Lethal ¹	Valid Crypto Keys and Time
1	4	PIN and NO	Valid Crypto Keys and Time
2	16	3D ² , PIN and NO	Valid Crypto Keys, Time, and Navigation Data
2	17	3D ² and Mode 1, 2 Codes	Valid Crypto Keys, Time, and Navigation Data
2	18	3D ² and Mode 3/A, C Codes	Valid Crypto Keys, Time, and Navigation Data
2	19	3D ² and Lethal ¹	Valid Crypto Keys, Time, and Navigation Data
2	20	3D ² , PIN and High-Res PIN	Valid Crypto Keys, Time, and Navigation Data

- ¹ Reserved for shooter platforms only
- ² 3D = position (latitude, longitude, altitude)

Mode 5 Level 1, Improved Q&A Identification

- Secure friend-from-friend ID
 - 16k PIN codes plus 2048 National Origin (NO) Codes (11-bit)
 - Mode 1, 2, 3/A , C, I/P, X and emergency data
 - Lethal interrogation message included to indicate engagement intent

- High confidence ID in any scenario
 - Provides higher P-id and increased system capacity
 - Provides longer ID range with modest processing gain
 - Eliminates most shortcomings of Mark XII including mutual interference, garbling, exploitation and spoofing

- Reduces interference to civil ATC
 - Message structure specifically designed to reduce interference
 - Interrogation rates reduced to less than half of Mark XII

Mode 5 Level 1 Operation

Mode 5 replies have a random range delays to reduce garble and mutual interference

Mark XII replies all have same range delay and signal structure

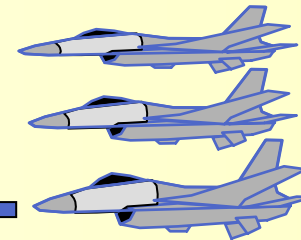
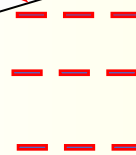
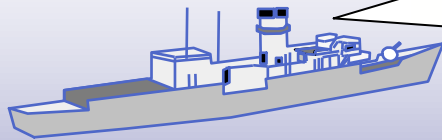

Mode 5 replies have more security bits to reduce exploitation and spoofing

Mode 5 reply spreading codes provide automatic de-Fruiting and improved performance in fading

Mode 5 Level 1 Performance

Parameter	Performance
Probability of ID	- Significant improvement over Mode 4
Range Accuracy	- 4 Times Improvement Over Mode 4
Azimuth Accuracy	- Similar To Mode 4
Range Resolution	- No lower limit unlike Mode 4 - Allows for separate ID of two (2or more) closely-spaced friendly targets
Azimuth Resolution	- No lower limit unlike Mode 4 - Allows for separate ID of two (2) closely-spaced friendly targets
Link Margin	- Processing gain provides $\approx 2X$ the range of Mode 4
Target Data	- Non-garbled M1, M2, M3/A, MC, PIN, and NO
Security	- Supports 360° continuous interrogation mode
ATC Compatibility	- No impact to ATC transponders
Radar Correlation	- Driven by improved range/azimuth accuracy and target resolution versus Mode 4

Mode 5 Level 2 Situation Awareness

- Mode 5 Level 2 provides for passive detection and triggered detection
- Position reports convey secure position and ID
 - GPS/INS position reporting by aircraft, ground and surface vehicles
 - ID includes Mark XII data, platform pin, mission code
 - Reports transmitted when interrogated and randomly as Squitters
- Identifies and locates friends with only one report
 - Much higher Pd and system capacity
 - Relative GPS accuracy between platforms
- Improves radar correlation
 - Four orders of magnitude improvement in correlation volume

Mode 5 Level 2 Situational Operation

A Non-Triggered M5L2 Position Report is "Squittered" by L@ Transponders at low rate for 360° situational awareness

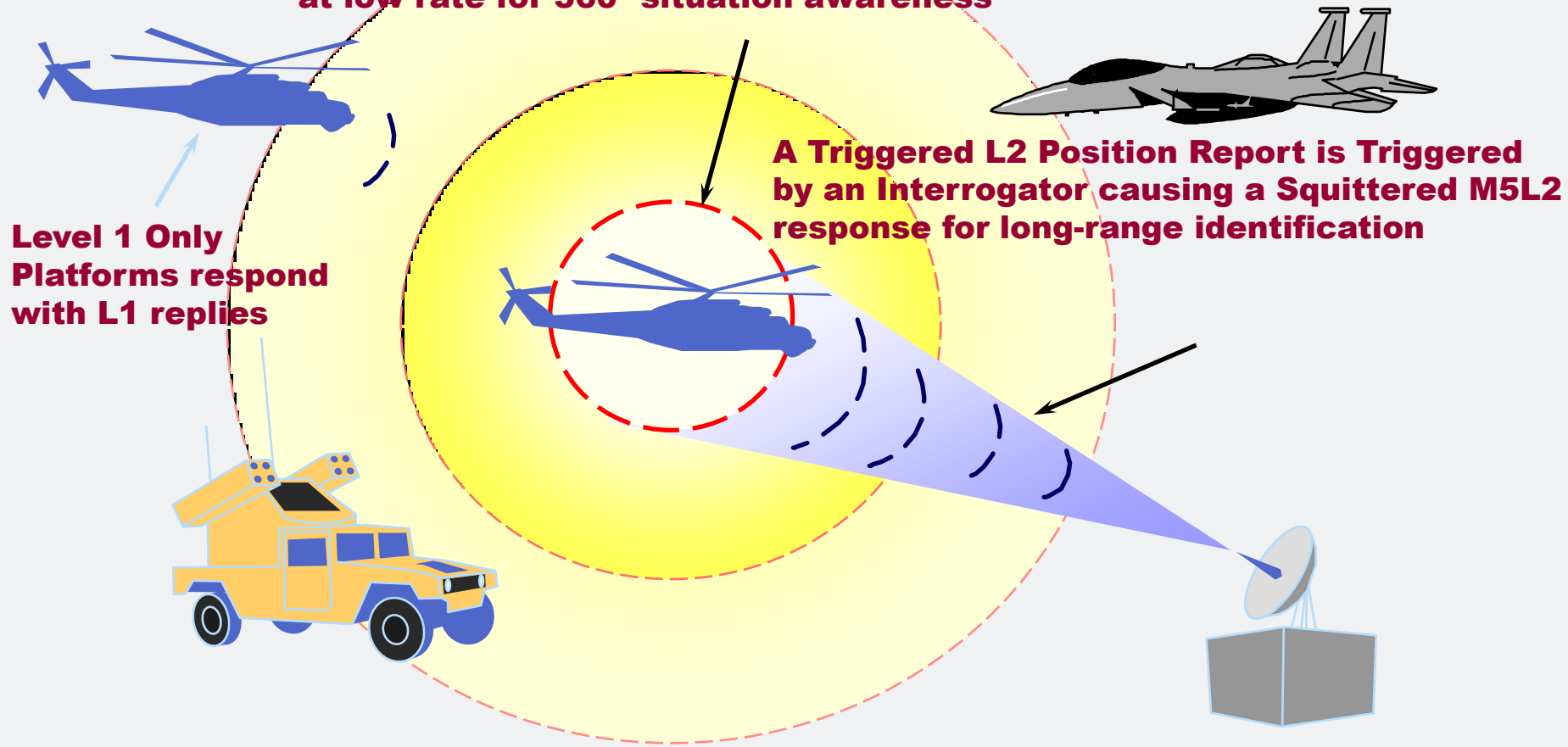

M5 Level 1 Only Transponders Respond in Level 1 during Level 2 Interrogations

Mode 5 Level 2 Passive Reception Performance

Parameter	Performance
Situational Awareness	
Range	<ul style="list-style-type: none"> - \approx 50 NM using typical Omni-directional receiving antennas - Range can be significantly improved through the use of a multi-channel system using high-gain antennas such as the Telephonics AN/UPR-4(V) PDRS
Resolution	<ul style="list-style-type: none"> - Latitude: 250 ft. - Longitude: 250 ft. - Altitude: 50 ft.
Accuracy	<ul style="list-style-type: none"> - Relative GPS
Probability of ID	<ul style="list-style-type: none"> - > 99%



SSR/IFF Processing Challenges

- FRUIT: False Replies Unsynchronized In Time
 - Replies received by an interrogator that were generated by a transponder in response to a different interrogator interrogation
 - Since multiple interrogators use asynchronous interrogations, the received range of a FRUIT reply is not synchronous to the intended interrogator range timing
- Telephonics Interrogators incorporate:
 - Pseudo-random interrogation stagger to minimize FRUIT replies from correlating in range and causing a false target
 - GTC: Used to help eliminate low level FRUIT replies
 - A small PRI to PRI reply range correlation window: Used to accept real synchronous replies while minimizing FRUIT replies from correlating in range like real replies
 - A small PRI to PRI antenna beam leading edge reply detection criteria and reply confidence criteria are used to maximize probability of detection and minimize false reports from FRUIT
- Targets must meet the leading edge and reply count confidence criteria to be reported



Ground Interrogators



Airborne Interrogators

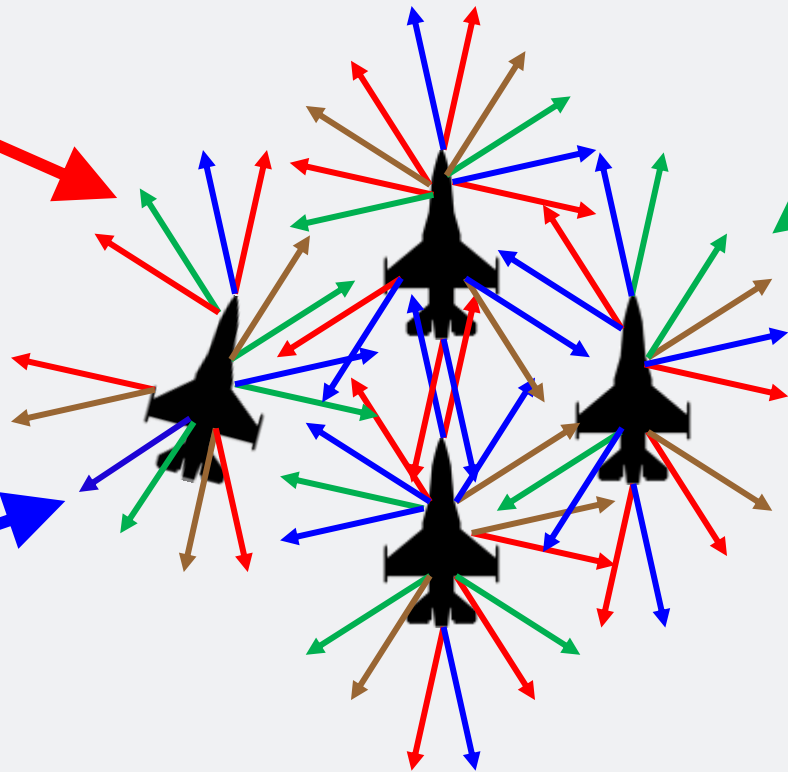

Mobile Interrogators



Surface Ship Interrogators

SIF Reply Pulses

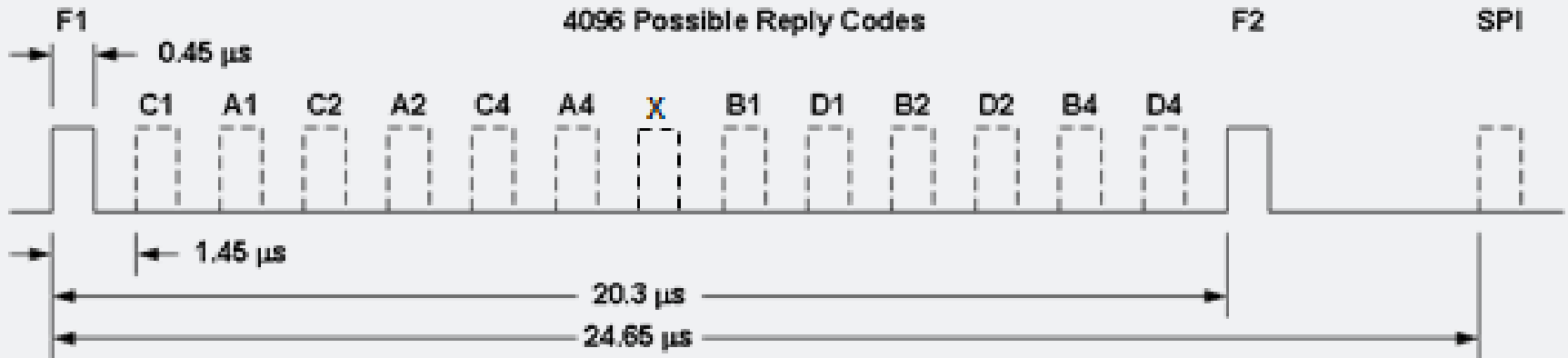

Garble Condition

- Garble conditions occur when two or more closely spaced replies overlap the $1.45 \pm 0.40 \mu\text{sec}$ pulse position boundary's
 - Other closely spaced reply's that do not overlap the pulse positions but are between pulse positions are referred to as “Interleaved” replies
- Garble: Replies overlap in time such that some individual code pulses are overlapped and can not clearly be associated with one reply or the other

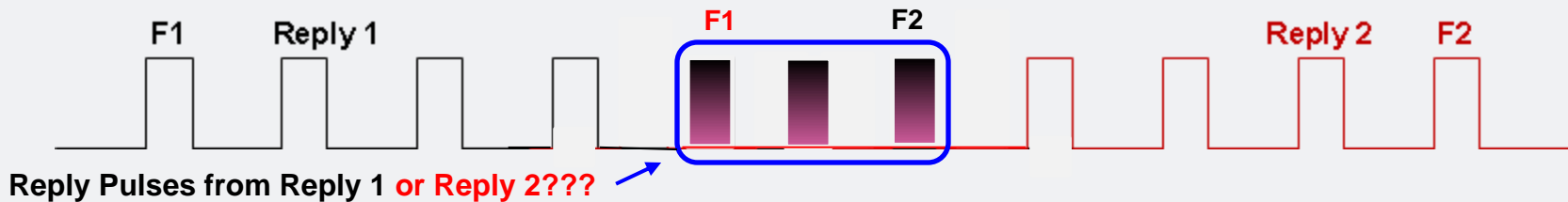

- Correct code cannot be determined (i.e. “garbled reply code”)
- Both replies when extracted are marked as garbled
- Multiple ungarbled reply codes for the same mode are required for “valid” code determination
- Internal SIF plot tracking may be used to aid in correct code determination on a scan to scan basis
- The SIF code in target report will be marked as “valid” or “garbled” as appropriate

Phantom Conditions

- Phantoms: Pulses from two or more closely spaced replies that align to form false F1/F2 brackets spaced @ 20.3 μ sec

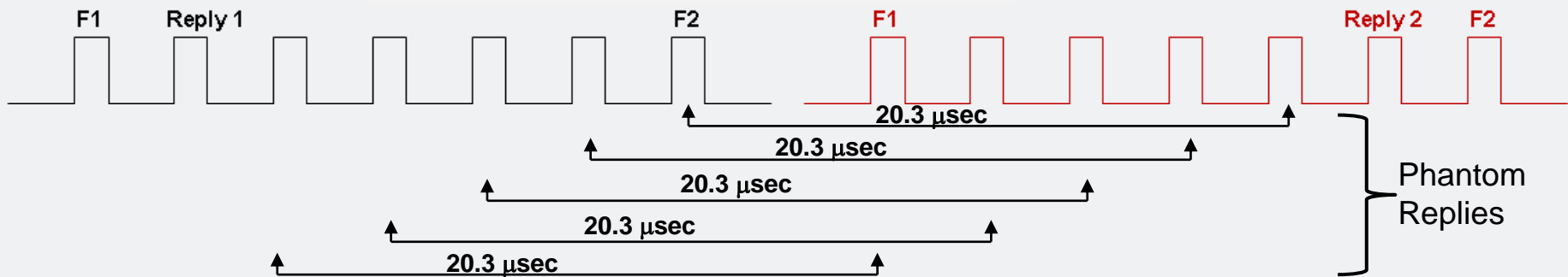
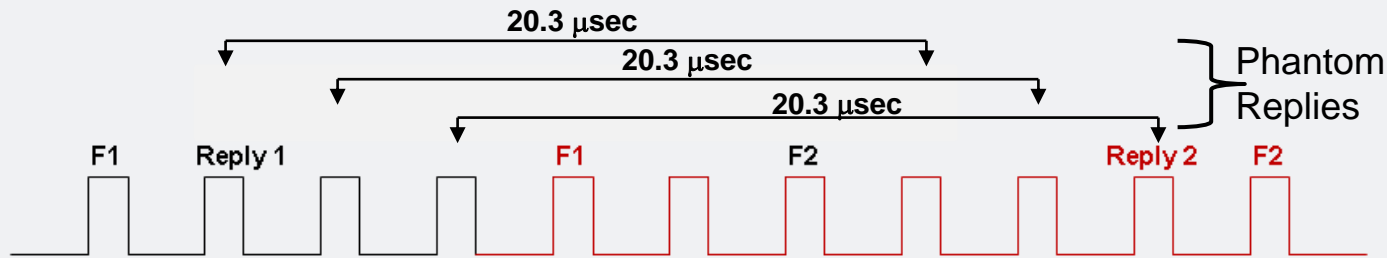

- Phantom 2: Garble caused by more than two (2) replies
- All Phantom conditions should be rejected by the reply extraction process

Replies from targets that are received after the interrogation period ends can look like low range replies on the next interrogation period sometimes considered “**Second-Time-Around**” replies

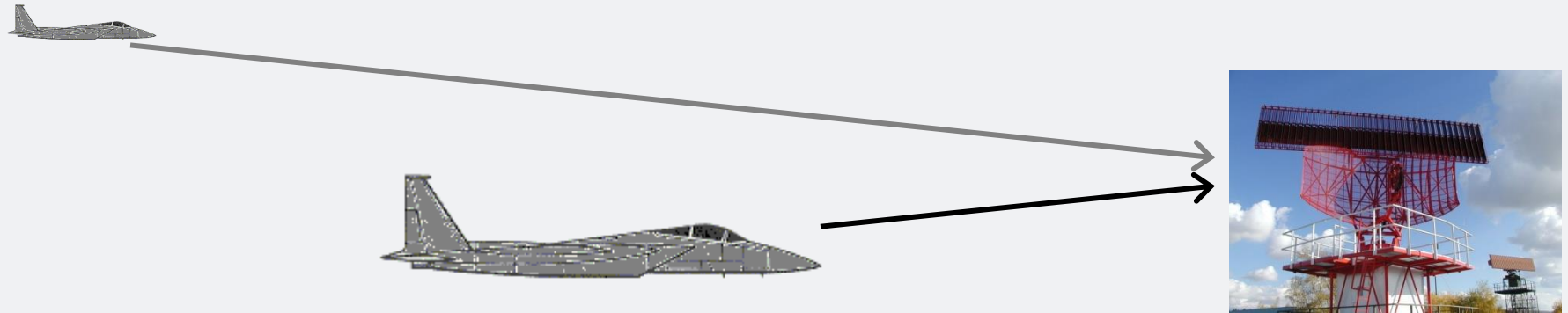

The replies from targets just past maximum range can be received in the beginning of the next interrogation period, and as such, can be declared a low range target. When this occurs, the received reply power level of the replies are not consistent, lower in RF power, with the expected interrogator reply range.

- GTC is one way to prevent “**Second-Time-Around**” replies from generating false targets
- Interrogation to interrogation timing stagger is another way to prevent “**Second-Time-Around**” replies from generating false targets

Weak Replies from Targets Past Max Interrogation Range

A target replying past the maximum interrogation range of a PRI interval may appear at a low range during the next PRI interrogation interval. In this case, the high-range reply will have a low RF power level not consistent with a real reply at that range and GTC is used to eliminate it.

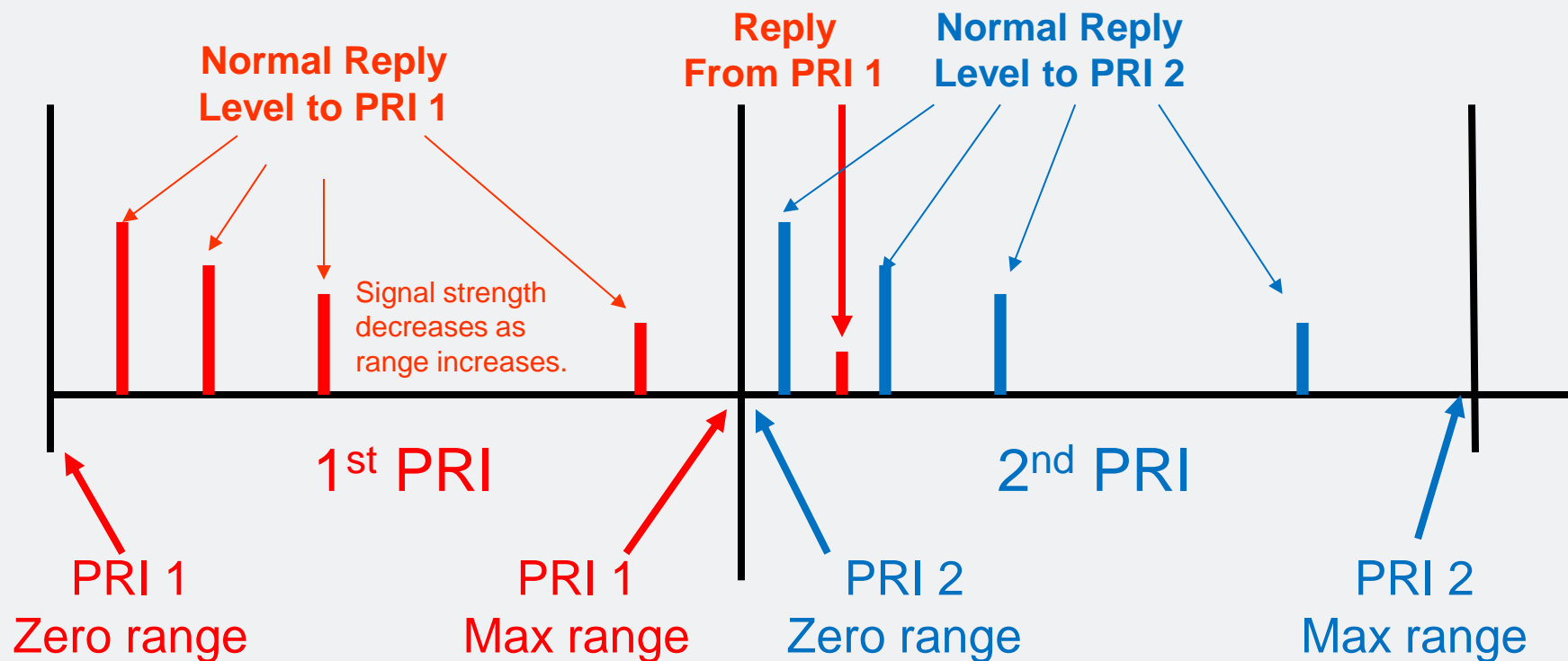

GTC Curve

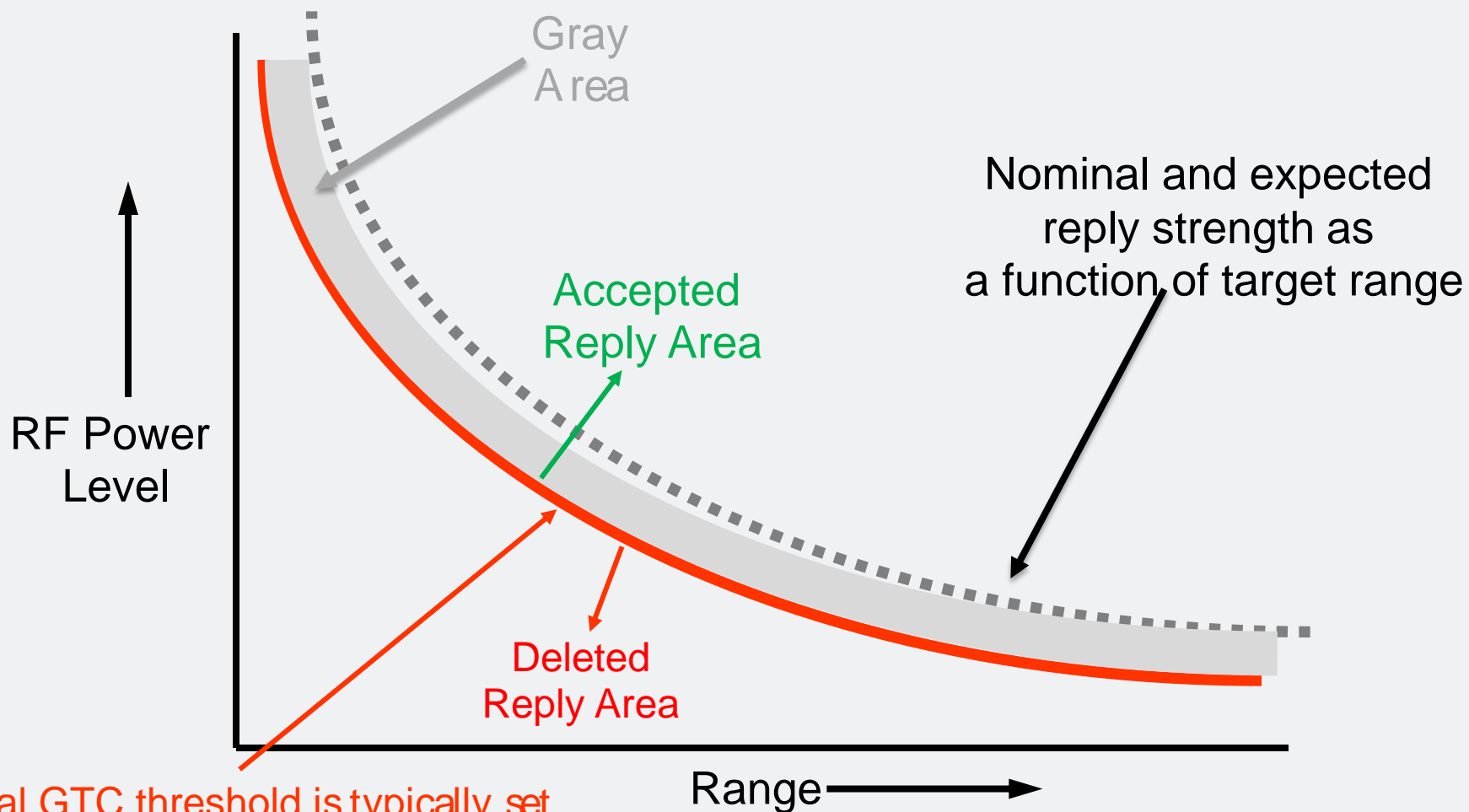

Typical GTC threshold is typically set 10-12dB below the expected reply RF level

GTC Curve (continued)

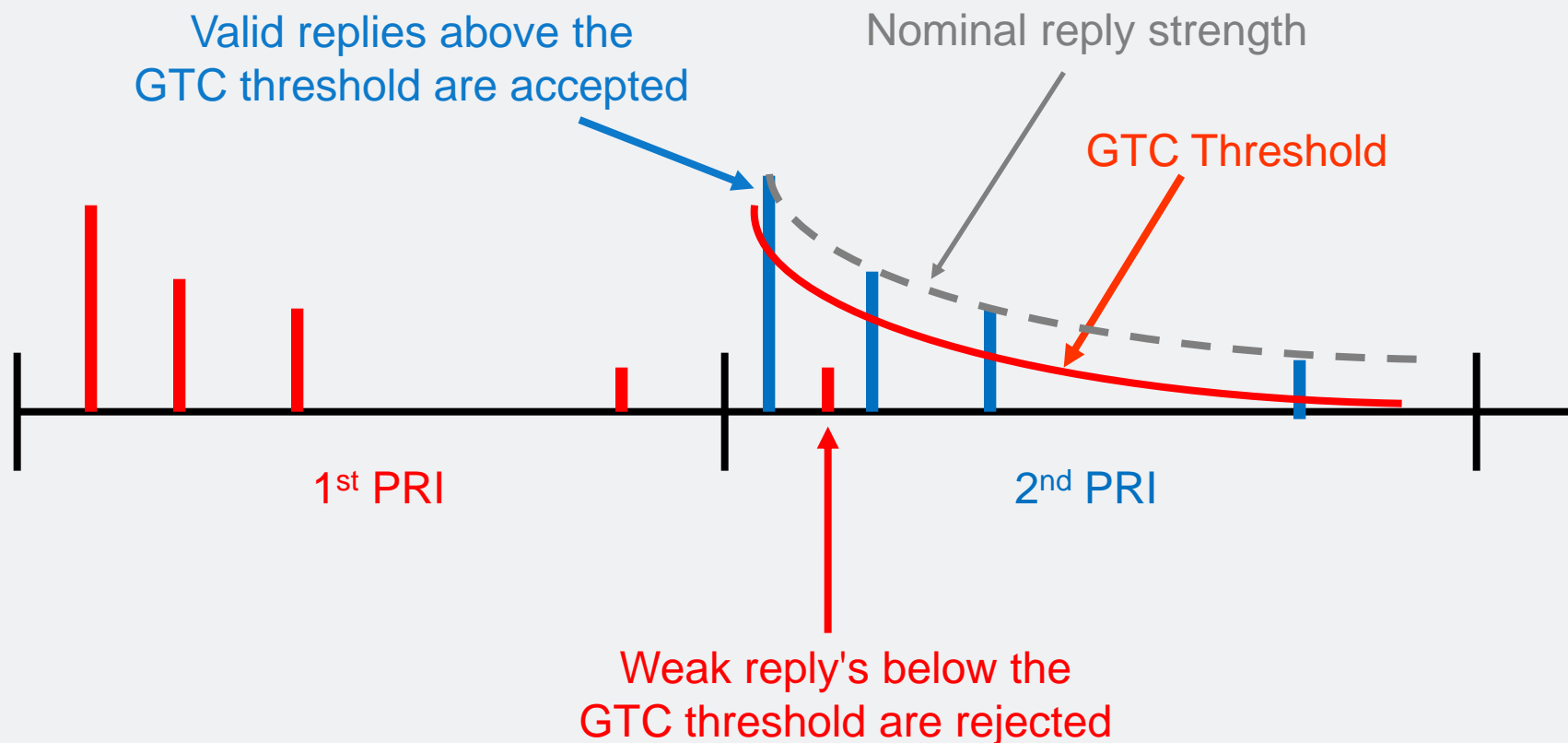

Multipath Basics

- The multi-path phenomena is, by far, one of the largest contributors to poor or degraded SSR system performance
- Multi-path interference can occur when a transmitted signal from a single source reaches its destination receiver from a direct path and at least one (1) reflected path
 - Interference can be constructive or destructive
- RF energy arriving at an antenna via two (2) different paths combines to add (constructive) or cancel (destructive), according to the relative phase between the two (2) signals
- The amount of signal interference is a function of:
 - Path delay between the incident and the reflected signal
 - Relative phase and power levels of the two (2) signals

Horizontal/Vertical, Uplink/Downlink Multi-path

- Horizontal plane multi-path:
 - Generates azimuthal reflections that cause false reports
 - Is usually caused by one (1) or more structures acting as a radar reflector
- Vertical plane multi-path:
 - Generates radial reflections that cause false reports and signal fading
 - Is usually caused by the earth acting as the radar reflector
- Uplink vertical plane multi-path:
 - May cause interrogation pulses to be misinterpreted by transponders
 - May result in the transponder replying in a wrong mode and at an incorrect range (mode conversion)
- Downlink multi-path:
 - May produce false (extra) replies, which, when received at the interrogator, are slightly delayed in time and may garble the real transponder code or could cause pulse cancelations or pulse additions, which would change the transponder code

Vertical Multi-Path

- Radar multi-path (or radar echo) is a:
 - Physical phenomena
 - Function of:
 - Height of the radar antenna above the earth
 - Height of the target aircraft above the earth
 - Range between the target and the radar
- In vertical multi-path cases, the earth acts as a reflector to radar signals and provides a second path for the radar signals to reach the receiving antenna
- Since the two (2) signal paths, one (1) direct and one (1) reflected, are different lengths, the signals reach the receiving antenna at different times
- Multi-path is deterministic in that once the geometry for the radar and the target is known, the “theoretical” multi-path delay can be calculated

Vertical Multi-Path (continued)

- In practice, the theoretical multi-path delay value is usually close to the actual or measured value
 - Differences are a function of:
 - Atmospheric conditions
 - Altitude measurement accuracies
 - Other factors
- SSR radar signals travel at approximately 12.359 μsec per NM (round trip)
 - As an example, a path length difference of 0.5 NM produces a multi-path delay of 6.1795 μsec
- Multi-path can occur on the:
 - Interrogation signal (called uplink multi-path)
 - Transponder reply signal (called downlink multi-path)

Vertical Multi-Path (continued)

- Combinations of uplink and downlink multi-path at certain geometries can produce four (4) or more reports in one (1) beam dwell from a single target
 - Two (2) or more reports can be generated from uplink multi-path conditions
 - Two (2) replies can be generated from each downlink reply
- Uplink multi-path occurs when the real and reflected interrogation signals reach the transponder at such a delay that the transponder decodes an incorrect pulse spacing, and therefore replies to the wrong mode
 - This is called Mode Conversion
 - Reply mode does not match the intended interrogation mode
 - In addition, an uplink multi-path reply will in most cases be generated at an incorrect range and may be reported above or below the real target range
- The range offset of an uplink multi-path reply is a function of target and platform geometry and the modes of interrogation

Ground Interrogator – Vertical Multi-Path Geometry

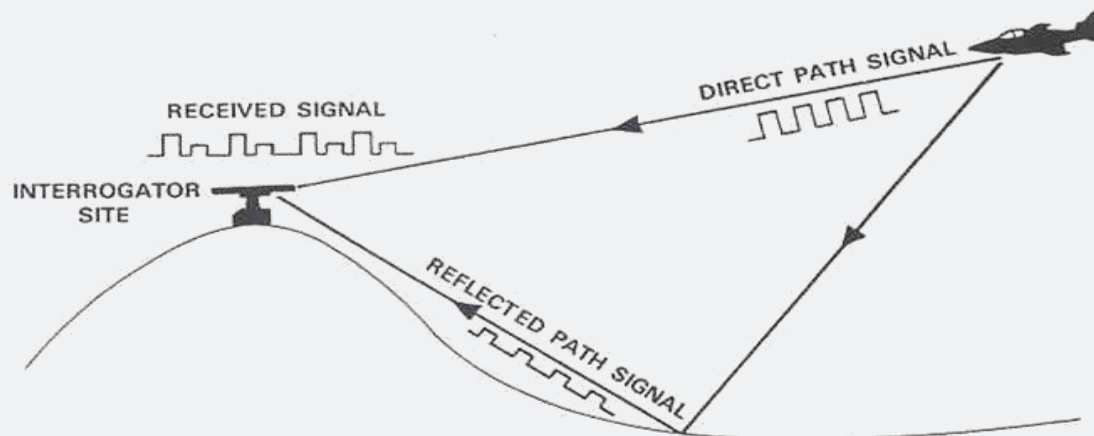

Fig. 7.10 Geometry of direct and reflected reply paths.

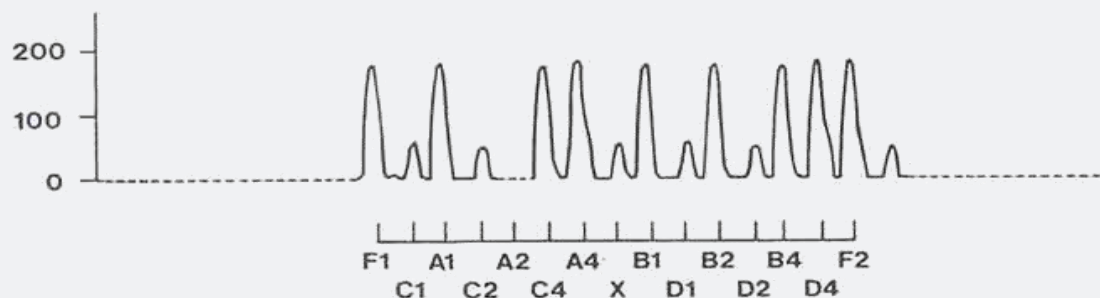
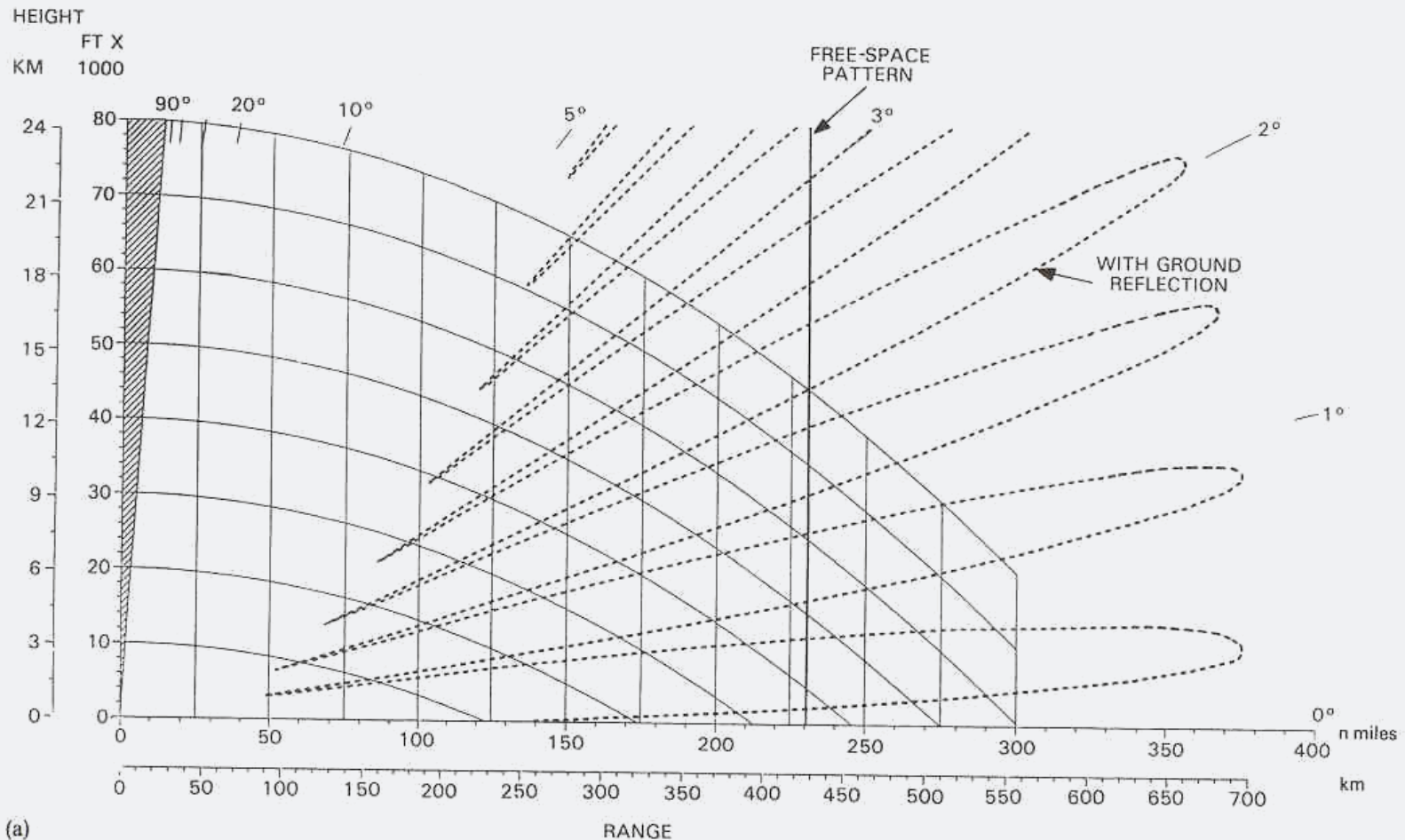

Fig. 7.11 Reply video with echo.

Note: Ground reflections also produce Up-link Multi-Path interference on the interrogation signals

Telephonics Interrogators identify and eliminate false replies due to vertical multi-path based on target geometry.

Lobbing due to Vertical Multi-Path



(a)

Lobbing as seen on Radar Display

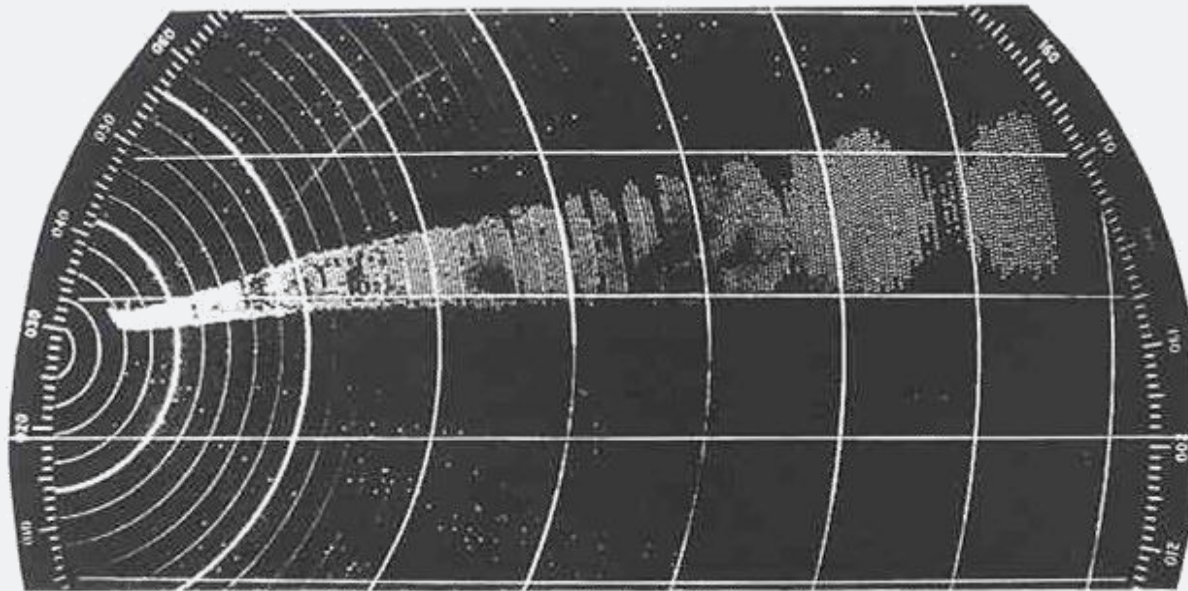

Elapsed time image radar display showing an aircraft flying through antenna minima caused by ground reflection

Horizontal Multi-Path Reflections

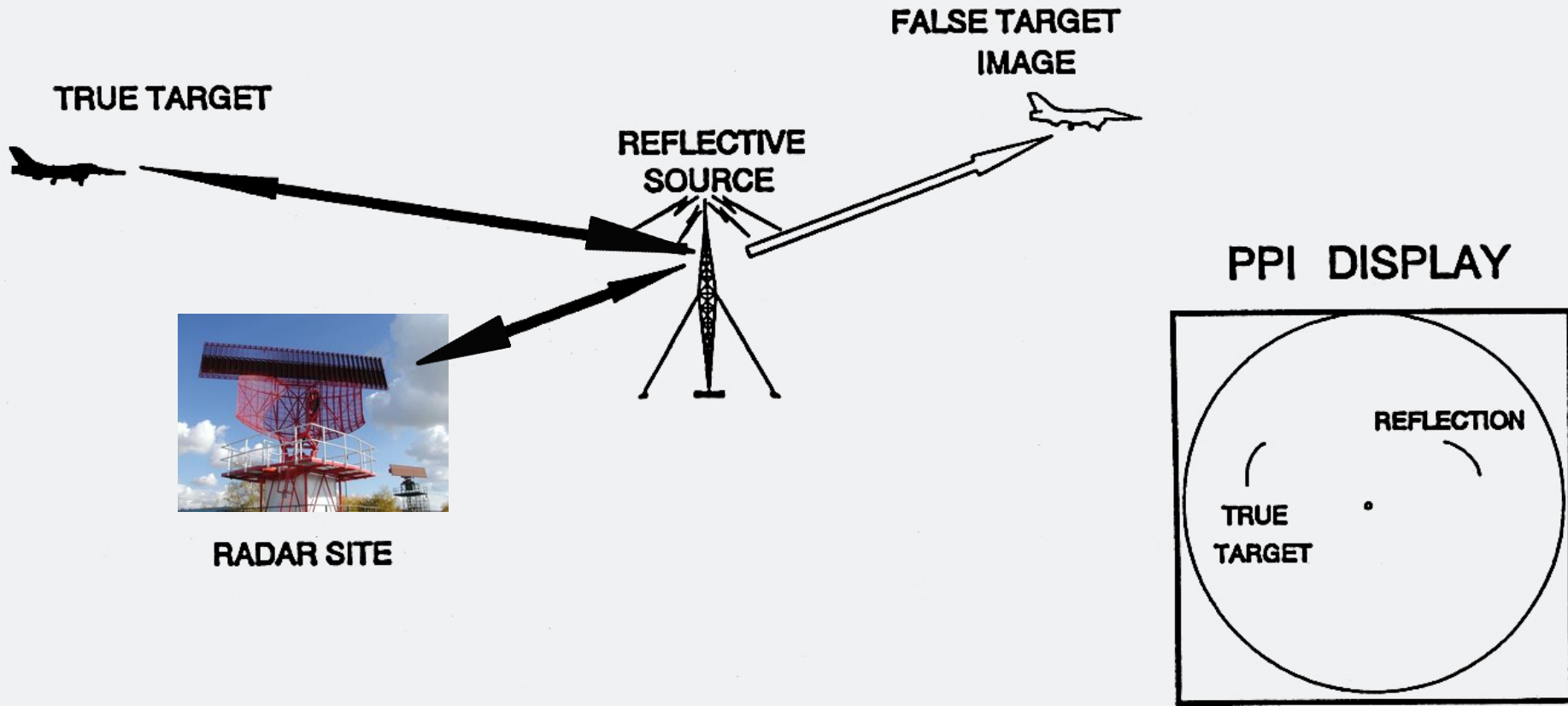

Overview

- Antenna patterns in free space can be distorted once installed at a ground site, on a ship, or on an airborne platform

- SSR antenna pattern distortion from platform structures and other causes performance degradation such as:
 - Azimuth accuracy
 - Code accuracy
 - False targets
 - Reduced Target detection

- Antenna pattern anomalies and Multi-path conditions can result in RF phase interference (constructive or destructive) that can alter the intended antenna pattern

Overview (continued)

- For airborne platforms (interrogators and transponders), a number of different factors can interfere with RF energy to cause very different antenna patterns from those intended
 - These include, but are not limited to:
 - Antenna installation
 - Aircraft skin effects
 - Wheels/Struts
 - Tail
 - Wings
 - Stores
 - Other appendages
- For ground systems the height of the antenna above the ground and other near by structures can alter the intended antenna patterns causing performance degradation
- Installed system performance must be a key requirement to SSR/IFF designs

Examples

Normal Antenna Patterns

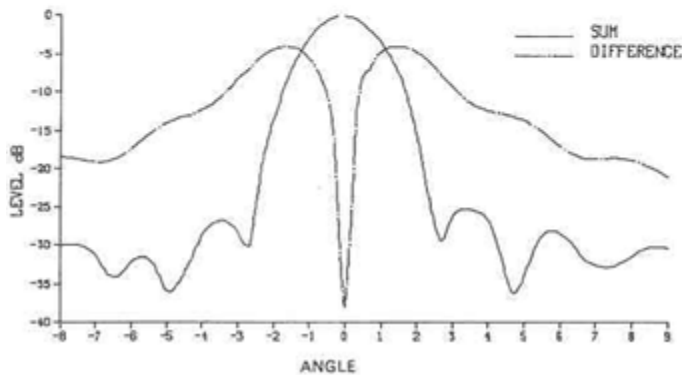
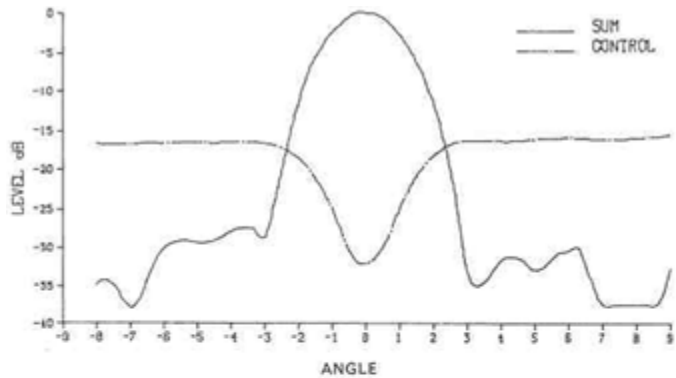

Distorted Antenna Patterns

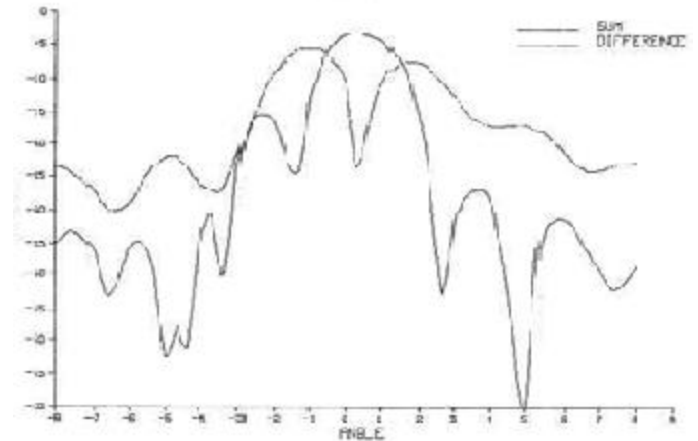
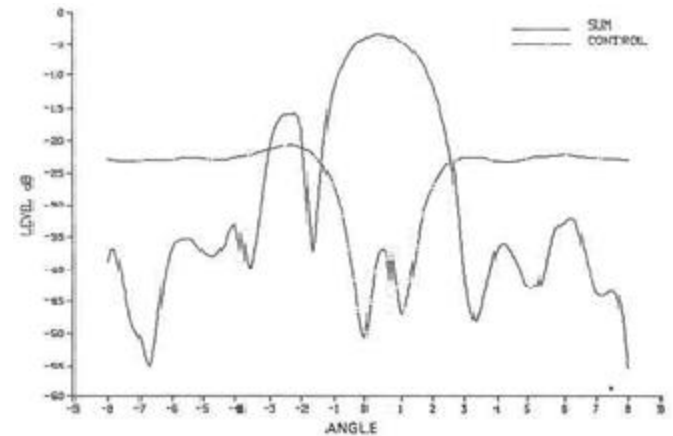



New Initiatives in SSR and IFF

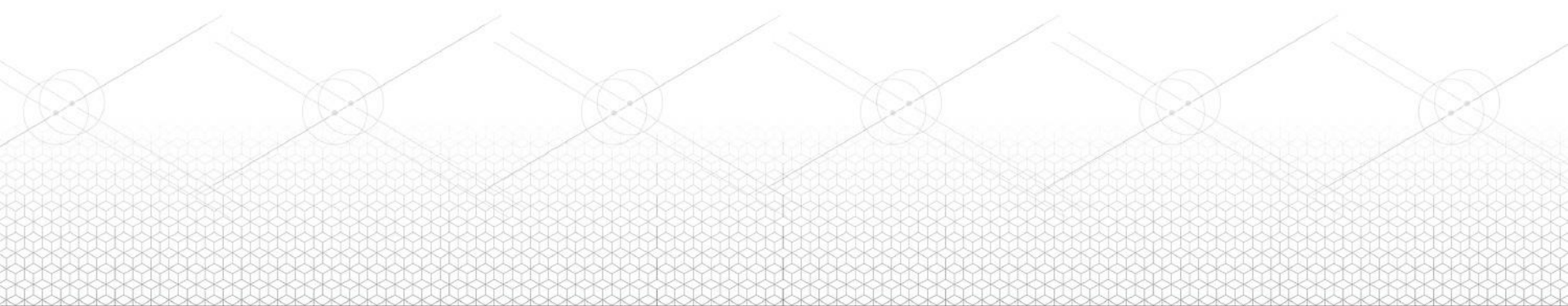

- New IFF Systems must be Lighter, Smaller and Require Less Prime Power to meet new Platform Requirements
- UAVs will require IFF/ATC transponders to share airspace with all other aircraft
- Transponder squitter capability in ADS-B, UAT and Mode 5 Level 2 will aid current ATC and IFF operations by providing accurate GPS position of air targets
- Passive Squitter Detection Systems will provide situational awareness to ATC and IFF end users
- GPS Denial and Jamming Protection coupled with GPS Denial/Jamming Detection and Reporting will be required to insure the GPS system is accurate and operational

- Secondary Surveillance Radar by Michael Stevens Published by Artech House 1988
- <https://www.radartutorial.eu>
- <https://www.eurocontrol.int>
- ICAO Annex 10 - Aeronautical Telecommunications - Volume IV- Surveillance Radar and Collision Avoidance Systems (Amendment no. 90 dated 16/7/18)
- Electronic Warfare and Radar Systems Engineering Handbook by Scott O'Neil Published by Military Book Shop 2012

- If you have any questions on this material or other SSR, IFF or ATC topics you can always email me at: messina@telephonics.com
- Thanks for the opportunity to brief you on SSR/IFF Systems

50 Years of Telephonics Secondary Surveillance Systems



42976